

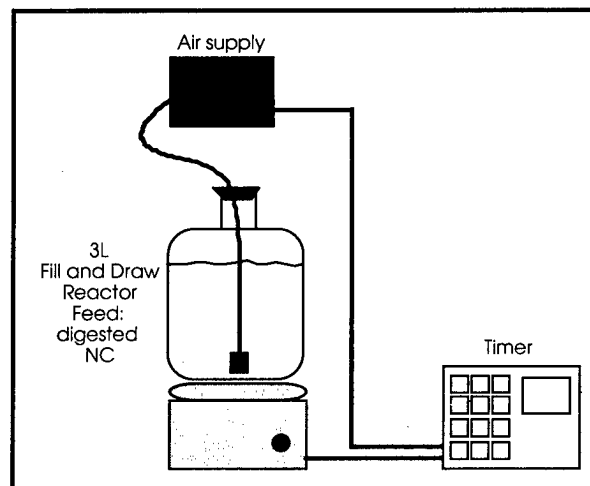

Alkaline Hydrolysis/Biodegradation of Nitrocellulose Fines

by
Byung J. Kim, James E. Alleman, and David M. Quivey



19990119 072

Cellulose nitrate constitutes an important industrial feedstock, with applications ranging from fingernail polish and photographic films, to explosives. The high level of nitration required for these explosive materials creates a significant environmental problem with respect to the necessary degradation of waste "fines" inevitably discharged from their manufacturing operations. These waste solids have proven to be remarkably stable, leading to a traditional reliance on open-field incineration as a means of disposal.

This research explored an alternative degradation procedure to eliminate the waste fines based on alkaline hydrolysis followed by

biodegradation. In particular, the effort focused on optimizing the hydrolysis operation in terms of solids reduction, practicality, and cost. In addition, biodegradation studies were conducted on the resulting hydrolysate to determine under what conditions amenability to biodegradation was maximized. Primarily using sodium hydroxide at low concentrations and temperatures, this research effort successfully achieved complete solubilization and denitration of the nitrocellulose. The resulting hydrolysate, containing significant concentrations of nitrite and nitrate, proved to be substantially amenable to aerobic biodegradation by an acclimated, mixed bacterial culture.

The contents of this report are not to be used for advertising, publication, or promotional purposes. Citation of trade names does not constitute an official endorsement or approval of the use of such commercial products. The findings of this report are not to be construed as an official Department of the Army position, unless so designated by other authorized documents.

DESTROY THIS REPORT WHEN IT IS NO LONGER NEEDED

DO NOT RETURN IT TO THE ORIGINATOR

USER EVALUATION OF REPORT

REFERENCE: USACERL Technical Report 98/65, *Alkaline Hydrolysis/Biodegradation of Nitrocellulose Fines*

Please take a few minutes to answer the questions below, tear out this sheet, and return it to USACERL. As user of this report, your customer comments will provide USACERL with information essential for improving future reports.

1. Does this report satisfy a need? (Comment on purpose, related project, or other area of interest for which report will be used.)

2. How, specifically, is the report being used? (Information source, design data or procedure, management procedure, source of ideas, etc.)

3. Has the information in this report led to any quantitative savings as far as manhours/contract dollars saved, operating costs avoided, efficiencies achieved, etc.? If so, please elaborate.

4. What is your evaluation of this report in the following areas?

a. Presentation: _____

b. Completeness: _____

c. Easy to Understand: _____

d. Easy to Implement: _____

e. Adequate Reference Material: _____

f. Relates to Area of Interest: _____

g. Did the report meet your expectations? _____

h. Does the report raise unanswered questions? _____

i. General Comments. (Indicate what you think should be changed to make this report and future reports of this type more responsive to your needs, more usable, improve readability, etc.)

5. If you would like to be contacted by the personnel who prepared this report to raise specific questions or discuss the topic, please fill in the following information.

Name: _____

Telephone Number: _____

Organization Address: _____

6. Please mail the completed form to:

Department of the Army
CONSTRUCTION ENGINEERING RESEARCH LABORATORIES
ATTN: CECER-TR-I
P.O. Box 9005
Champaign, IL 61826-9005

REPORT DOCUMENTATION PAGE

Form Approved
OMB No. 0704-0188

Public reporting burden for this collection of information is estimated to average 1 hour per response, including the time for reviewing instructions, searching existing data sources, gathering and maintaining the data needed, and completing and reviewing the collection of information. Send comments regarding this burden estimate or any other aspect of this collection of information, including suggestions for reducing this burden, to Washington Headquarters Services, Directorate for Information Operations and Reports, 1215 Jefferson Davis Highway, Suite 1204, Arlington, VA 22202-4302, and to the Office of Management and Budget, Paperwork Reduction Project (0704-0188), Washington, DC 20503.

1. AGENCY USE ONLY (Leave Blank)		2. REPORT DATE August 1998	3. REPORT TYPE AND DATES COVERED Final	
4. TITLE AND SUBTITLE Alkaline Hydrolysis/Biodegradation of Nitrocellulose Fines			5. FUNDING NUMBERS 4A162720 D048 TE7	
6. AUTHOR(S) Byung J. Kim, James E. Alleman, and David M. Quivey				
7. PERFORMING ORGANIZATION NAME(S) AND ADDRESS(ES) U.S. Army Construction Engineering Research Laboratories (USACERL) P.O. Box 9005 Champaign, IL 61826-9005			8. PERFORMING ORGANIZATION REPORT NUMBER TR 98/65	
9. SPONSORING / MONITORING AGENCY NAME(S) AND ADDRESS(ES) U.S. Army Environmental Center (USAEC) HQ, IOC ATTN: SFIM-AEC-ET Bldg 4430, Beal Road Aberdeen Proving Ground, MD 21010-5401			10. SPONSORING / MONITORING AGENCY REPORT NUMBER Rock Island, IL 61299-1000	
11. SUPPLEMENTARY NOTES Copies are available from the National Technical Information Service, 5285 Port Royal Road, Springfield, VA 22161.				
12a. DISTRIBUTION / AVAILABILITY STATEMENT Approved for public release; distribution is unlimited.			12b. DISTRIBUTION CODE	
13. ABSTRACT (Maximum 200 words) Cellulose nitrate constitutes an important industrial feedstock, with applications ranging from fingernail polish and photographic films, to explosives. The high level of nitration required for these explosive materials creates a significant environmental problem with respect to the necessary degradation of waste "fines" inevitably discharged from their manufacturing operations. These waste solids have proven to be remarkably stable, leading to a traditional reliance on open-field incineration as a means of disposal. This research explored an alternative degradation procedure to eliminate the waste fines based on alkaline hydrolysis followed by biodegradation. In particular, the effort focused on optimizing the hydrolysis operation in terms of solids reduction, practicality, and cost. In addition, biodegradation studies were conducted on the resulting hydrolysate to determine under what conditions amenability to biodegradation was maximized. Primarily using sodium hydroxide at low concentrations and temperatures, this research effort successfully achieved complete solubilization and denitration of the nitrocellulose. The resulting hydrolysate, containing significant concentrations of nitrite and nitrate, proved to be substantially amenable to aerobic biodegradation by an acclimated, mixed bacterial culture.				
14. SUBJECT TERMS nitrocellulose fines solid wastes biodegradation			15. NUMBER OF PAGES 134	
			16. PRICE CODE	
17. SECURITY CLASSIFICATION OF REPORT Unclassified			18. SECURITY CLASSIFICATION OF THIS PAGE Unclassified	
			19. SECURITY CLASSIFICATION OF ABSTRACT Unclassified	
			20. LIMITATION OF ABSTRACT SAR	

Foreword

This study was conducted for the Directorate of Military Programs, Headquarters, U.S. Army Corps of Engineers (HQUSACE), under Project 4A162720D048, "Environmental Quality Technology (Industrial Operations Pollution Control Technology);" Work Unit TE7, "Nitrocellulose Fines Abatement." The technical monitor was Gene Fabian, SFIM-AEC-ET and James Small, AMSIO-EQC.

The work was performed by the Industrial Operations Division (UL-I) of the Utilities and Industrial Operations Laboratory (UL), U.S. Army Construction Engineering Research Laboratories (USACERL). The USACERL principal investigator was Dr. Byung J. Kim. Dr. James E. Alleman and Dr. David M. Quivey were a professor and a graduate student at Purdue University, West Lafayette, IN. This technical report is based on Dr. Quivy's Ph.D. thesis. Dr. Byung Kim provided the research topic and served as Ph.D. thesis advisory committee member to reflect the Army's needs. Walter J. Mikucki is Chief, CECER-UL-I; Dr. John T. Bandy is Operations Chief, CECER-UL; and Gary W. Schanche, CECER-TD, was the responsible Technical Director. The USACERL technical editor was William J. Wolfe, Technical Information Team.

COL James A. Walter is Commander and Dr. Michael J. O'Connor is Director of USACERL.

Contents

SF 298	1
Foreword	2
List of Figures and Tables	5
1 Introduction	9
Background	9
Objectives	10
Approach	10
Scope	11
Mode of Technology Transfer	11
2 Literature Review	12
Nitrocellulose Background and Industrial Use	12
Cellulose Structure and Properties	14
Nitrocellulose Structure and Properties	18
Treatment Alternatives for Nitrocellulose Wastes	22
Hydrolysis Reactions	25
Biological Treatment	36
3 Analytical Methods and Test Procedures	41
Analytical Methods	41
Test Procedures	45
4 Results and Discussion	59
Nitrocellulose Selection and Analysis	59
Preliminary Alkaline Hydrolysis and Biodegradation Studies	60
Hydrolysis Optimization and Kinetic Studies	67
Chemical Characterization of the Hydrolysate	79
Biological Treatment Studies	95
5 Conceptual Design	109
Conceptual Design Development and Discussion	109
Conceptual Design Summary	114
6 Conclusions and Recommendations	119

Bibliography..... 123

Abbreviations and Initialisms 129

Distribution

List of Figures and Tables

Figures

1	Molecular relationship between glucose, starch, and cellulose.	16
2	Molecular structure of NC (theoretical "trinitrate" form).....	20
3	Alkaline degradation scheme proposed by Jackson and Hudson (1936).	33
4	Schultz-Tiemann test apparatus.....	44
5	Reactor assembly used in alkaline hydrolysis studies.	46
6	Molecular weight distribution protocol schematic.....	51
7	Individual ultrafiltration cell.	51
8	Condensed protocol for Microtox Basic Test (Microbiotics Corp., 1992).	53
9	Condensed protocol for Microtox 100% Test (Microbiotics Corp., 1992).	53
10	N-CON BOD reactor assembly.	55
11	Nitrification/denitrification/treatability reactor configuration.	57
12	Treatability study continuous flow stirred tank reactor configuration.....	58
13	Nitrogen yield relative to caustic species.	60
14	Nitrogen yield relative to caustic concentration.....	61
15	Nitrogen yield relative to hydrolysis temperature.	61
16	Nitrogen yield relative to NC concentration.	62
17	BOD of post-hydrolysis solids.	65
18	BOD of the complete post-hydrolysis liquor.	66
19	Results of the Plackett-Burman screening test.	67
20	Determination of the statistical significance of each main effect.....	69
21	$\ln [TSS]$ versus time, as a function of caustic dose.....	70
22	$\ln (-d[TSS]/dt)$ versus $\ln [OH^-]$	71
23	$\ln [TSS]$ versus time, as a function of temperature.	72
24	$\ln k_{OH}$ versus $1/T$ ($^{\circ}K$).	73
25	$\ln [N]$ versus time, as a function of caustic dose.....	74
26	$\ln (-dN/dt)$ versus $\ln [OH^-]$	74
27	$\ln [N]$ versus time, as a function of temperature.....	75
28	$\ln k_{OH}$ versus $1/T$ ($^{\circ}K$).	75
29	Solubilization prediction for an intermediate temperature/low caustic combination.	77
30	Solubilization prediction for a low temperature/intermediate caustic combination.	77

31	Denitration prediction for a low temperature/intermediate caustic combination.....	78
32	Simultaneous solubilization and denitration.	78
33	Molecular weight distributions of hydrolysate following 30 °C digestion at: (a) 2% NaOH, (b) 6% NaOH, and (c) 10% NaOH.	80
34	Molecular weight distributions of hydrolysate following 70 °C digestion at: (a) 2% NaOH, (b) 10% NaOH.....	81
35	Hydrolysate COD following hydrolysis at (a) 30 °C, (b) 50 °C, and (c) 70 °C.....	85
36	Hydrolysate COD following hydrolysis at (a) 50 °C, and (b) 70 °C.	86
37	Hydrolysate carbohydrate analysis at (a) 30 °C and (b) 70 °C.	91
38	Hydrolysate cyanide analysis results following hydrolysis at (a) 30°C and (b) 70°C.	94
39	Hydrolysate BOD5 following hydrolysis at (a) 30°C, (b) 50°C, and (c) 70°C.	96
40	Decrease in total oxygen demand during a 120-hr BOD run for a hydrolysate digested at 70°C in 2% NaOH for 2.5 hours.	100
41	Decrease in total organic carbon during a 120-hr BOD run for a hydrolysate digested at 70°C in 2% NaOH for 2.5 hours.	100
42	CBOD/TOC (removed) ratios versus the hydrolysis conditions.	101
43	ROD/TOC (residual) ratios versus the hydrolysis conditions.	102
44	Microtox toxicity test results.	103
45	CFSTR influent and effluent nitrite concentration versus time.	105
46	CFSTR influent and effluent nitrate concentration versus time.	107
47	CFSTR influent and effluent TOC concentration versus time.	107
48	CFSTR influent and effluent COD concentration versus time.....	108
49	Treatability reactor MLVSS versus time.	108
50	Flow diagram of alkaline hydrolysis/biodegradation process with denitrification.	110
51	Conceptual design, optimum hydrolysis conditions.	115
52	Conceptual design, high caustic hydrolysis conditions.	116
53	Conceptual design, low temperature hydrolysis conditions.	117
54	Conceptual design, low temperature and caustic hydrolysis conditions.	118

Tables

1	Molecular weight of cellulose from Urbanski (1964).	15
2	NC molecular formula.	20
3	Solvents used for various NC grades from Dorée (1950).	21
4	Acid hydrolysis constants for various cellulosic materials from Humphrey (1979).	28
5	Kinetic parameters for the saponification of CA membranes.	36
6	Enzymes of the cellulase complex from Jeffries (1987).....	38
7	Preliminary hydrolysis testing parameters.	46

8	Low and high values for Plackett-Burman parameters.	48
9	12-run Plackett-Burman design for four process factors.....	48
10	Parameter setting during each trial.	49
11	Testing protocol for rate constant determination.	50
12	Nitrocellulose elemental analyzer results.....	59
13	Calculation of the magnitude of the main effects and the experimental error.	68
14	Analysis for determination of hydroxide order for solubilization.	71
15	Solubilization rate constants.	72
16	Arrhenius factors for the solubilization of nitrocellulose.	73
17	Analysis for the determination of hydroxide order for denitration.....	74
18	Denitration rate constants.	75
19	Arrhenius factors for the denitration of nitrocellulose.	76
20	Hydrolysate oxidation state determinations.	87
21	Sodium nitrate/glucose alkaline hydrolysis results.....	89
22	Possible NC degradation byproducts and their corresponding carbon oxidation states.....	89
23	Carbohydrate-COD correlation data.	92
24	BOD5/COD ratios as a function of the initial hydrolysis conditions.....	98
25	Hydrolysate nitrogen mass balance.....	106
26	Hydrolysate carbon mass balance.....	106

1 Introduction

Background

Cellulose nitrate, commonly known as nitrocellulose (NC), represents an important industrial feed stock with uses extending to both military and civilian industries. The term nitrocellulose actually refers to a number of compounds containing various amounts of nitrogen bound to a backbone cellulose structure.

The industrial use of NC is directly related to the average number of nitrate groups bound to the cellulose. The maximum percent of nitrogen by weight that the cellulose can contain is 14.15 percent in the trinitrate form. NC with a nitrogen content of ~11.5 to 12.5 percent is typically used in industry in the manufacture of lacquers, artificial leathers, and filter membranes. Highly nitrated NC, with a nitrogen content of ~12.5 to 13.5 percent, is a principal ingredient of propellants, smokeless powders, and some explosives, and is typically referred to as "gun cotton."

The Radford Army Ammunition Plant (RAAP) in Radford, VA, is the only active manufacturer of military grade NC in the United States. During the manufacture of NC, large quantities of waste or unusable nitrocellulose are generated. This residual or waste NC is composed of insoluble fibers, of which about 90 percent by weight are under 40 μm particle size (Kim et al. 1997). Because of this small size, these residuals are often referred to as NC "fines." Customarily, these "fines" have been allowed to escape with the wash water to receiving waters after sedimentation and neutralization of the acid. Since tests have shown that NC is nontoxic to aquatic organisms, total suspended solids (TSS) has been the only water quality criteria limiting this discharge (Roberts and Hartley 1992). The NC fines recovered by sedimentation, often called "pit cotton," may currently be reused in the production of lower grade propellants. However, the Army is expected to terminate the reuse of NC in the near future. The waste NC is considered a hazardous waste because of its reactivity, and has traditionally been open burned. Kim et al. (1997) gives a complete NC process flow diagram and detailed discussion of NC fine generation data.

The practices of discharging the unsettled NC or burning the resulting NC sludge have come under a great deal of scrutiny because of their potential effect

on both air and receiving water quality. The disposal of these "fines" by some alternative means represents a paradoxical environmental problem. On the one hand, these munitions-grade products are not suitable candidates for landfilling because of their explosive instability. On the other hand, particulate NC residuals have proven to be surprisingly stable when exposed to many conventional waste degradation strategies. Because NC is an extensively substituted cellulose compound, it is not readily subject to direct microbiological attack and is not broken down by microbes in receiving water systems. However, traditional treatment such as aerobic biodegradation can occur if adequate pretreatment, such as alkaline hydrolysis, is applied to convert the insoluble and nonbiodegradable particulate NC into usable substrate. This study was undertaken to determine the effectiveness of an alkaline hydrolysis pretreatment step on a concentrated NC waste stream. Optimizing this pretreatment and combining it with a traditional biodegradation phase may demonstrate the utility of the process.

Objectives

The major objectives of this research effort were to:

1. Determine the parameters and the range of conditions affecting the alkaline hydrolysis pretreatment process.
2. Develop empirical models predicting the breakdown of the nitrocellulose when subjected to alkaline hydrolysis.
3. Optimize the hydrolysis process to maximize susceptibility to biodegradation while minimizing costs and any potentially adverse impacts to the environment.
4. Assess the impact of the hydrolysate as a waste stream to an activated sludge treatment plant.
5. Attempt to chemically characterize the hydrolysate.
6. Develop an engineering concept for alkaline hydrolysis and treatment system for waste NC.

Approach

1. Bench-scale alkaline digesters were built and their performance data were evaluated for the hydrolysis of concentrated NC fines.

2. The use of different alkaline chemicals were analyzed with varying concentrations and reactor temperatures to optimize the alkaline hydrolysis process.
3. The experimental data were used to develop and validate mathematical model for alkaline hydrolysis of NC.
4. Biological treatability of alkaline hydrolysate was evaluated to ultimately break down NC.
5. Based on the bench-scale study results, a conceptual framework for technical transfer was developed.

Scope

This work is based on bench-scale evaluation of alkaline digestors. Scale-up of the alkaline digester to production levels was beyond the scope of work. A pilot-scale alkaline digester and full scale demonstration should precede the implementation of the technology.

Mode of Technology Transfer

It is anticipated that the environmental compliance technology developed in this study will be validated and demonstrated through the Strategic Environmental Research and Development Program (SERDP) or the Environmental Science Technology Certification Program (ESTCP).

2 Literature Review

Nitrocellulose Background and Industrial Use

Urbanski (1964) published an extremely complete, and now extensively quoted, reference on explosives and the explosives industry. Included in this work was a definitive history of the discovery and subsequent commercial manufacture of NC.

The first reference to the preparation of NC was made by Braconnot (1833). In his work, Braconnot prepared a number of products by dissolving substances of vegetable origin in nitric acid. He called the resultant product "Xyloidine." Xyloidine was described as an easily inflammable solid that would burn violently and completely leaving no residue. Based on current knowledge of the process by which Xyloidine was produced, it has been estimated that this product contained only 5 to 6 percent nitrogen.

Pelouze (1838) continued Braconnot's work by subjecting paper or cotton to the action of nitric acid. These investigations differed from the previous work in that the cellulose material was not dissolved in the nitrating acid. The final product was, however, similar.

Between 1840 and 1848, numerous investigators studied the nitration of cellulose. Schonbein (1846) was the first to apply for a patent to protect his newly developed process. Schonbein's process called for treating cotton in a mixture of nitric acid and sulfuric acid. However, numerous explosions occurred during the commercial manufacture of NC using Schonbein's process. A review of these accidents by Austrian authorities led them to issue an edict forbidding the manufacture of NC in Austria until the cause of these accidents was determined and the manufacturing process altered accordingly.

Abel (1868) was the first to explain that the accidents involving NC occurred as a result of incomplete removal of readily decomposable products, i.e., they were due to inadequate stabilization of the final product. Abel proposed boiling the guncotton with water followed by pulping the substance. This technique permitted the removal of the unstable products from inside the fibers. Abel thus prepared NC that was chemically stable and relatively safe.

Although Abel prepared a guncotton that was chemically stable, the practical application was still limited and its use as an explosive was considered a failure. A considerable advance in the application of NC for military purposes was made when Abel and Brown (1868) suggested using a compressed product as a high explosive. The detonation of this compressed NC was brought about by another new discovery, a detonation device filled with mercury fulminate. This compressed NC system was used in the manufacture of demolition charges and for filling mines and torpedoes. Safety of the NC was further increased when it was observed that moist NC, which was much safer to handle, could be ignited using a charge of dry NC with a detonator.

The widest military application for NC was realized when D. Mendeleev (1895) developed highly nitrated NC, which would dissolve in a mixture of alcohol and ether. The solvent combination, alcohol-ether, was used in the manufacture of smokeless propellants, and when combined with NC (~12.6 percent nitrogen) produced a highly efficient smokeless powder known as pyrocellulose.

Current military uses of NC include: the manufacture of propulsive powders for armaments and solid homogenous propellants. These can be classified into (Quinchon and Tranchant 1989):

- single-base powders (NC gelatinized by ether-alcohol or acetone solvent)
- double-base powders and homogenous propellants (NC gelatinized with nitroglycerin or other explosive oils)
- triple-base propellants (NC, NG, and NQ).

Nonmilitary uses of NC were developed in parallel with the military uses. Hyatt (1870, in Urbanski 1964), while looking for a substitute for ivory for the manufacture of billiard balls, discovered a form of plastic when NC was gelatinized in camphor. He called this plastic material "Celluloid." In 1886, Parker discovered that when NC was dissolved in a solvent and deposited on a support, a strong, glossy coating was produced. This was the beginning of the NC varnish industry. Godwin (1898, in Urbanski 1964) later used these same properties when he developed NC-based photographic film (Quinchon and Tranchant 1989).

Current civilian uses of NC are based on the same qualities of these thin films. These films combine an excellent chemical resistance to most common agents (water, weak acids, and hydrocarbons) with important mechanical properties, and the ability to form films with good covering potential, weak retention of solvent, and high drying speed. In addition, the risk of ignition is completely eliminated by the extreme thinness of the covering films. Current applications include: NC lacquers, varnishes for wood, varnishes for papers and cardboard,

fingernail polish, aluminum foil varnish, leather varnish, body repair kits for cars, and nitrocellulose inks for flexographic printing.

The overall importance of NC as a raw material in both civilian and military industries continues to grow. In 1989, the world market for all types of NC approached 80,000 tons per year (Urbanski 1964; Quinchon and Tranchant 1989).

Cellulose Structure and Properties

NC is just one of the many important derivatives of cellulose. Because the original cellulose structure is not drastically altered during its manufacture, NC retains many of the structural characteristics and properties of the parent cellulose material. Because of this, many of the concepts concerning NC are little more than adaptations of similar concepts known to be true for cellulose (Miles 1955).

Cellulose is the most abundant organic material on earth and because of its unique properties, one of the most important and widely used materials. Cellulose occurs throughout the vegetable kingdom as a constituent of the cell wall. In many plants, cellulose is the principal cell wall constituent, the other constituents being predominantly hemicellulose and lignin. The raw materials from which pure cellulose is obtained are thus more accurately termed lignocellulosic materials. The commercial importance of these materials is dependent on the ratio of the three primary constituents, with the most valuable being those with the highest concentration of cellulose. Commercially important sources of cellulose include: woods (both hardwoods and softwoods), grasses, most agricultural residues (i.e., sugar cane bagasse, corn stalks, wheat straw, etc.), and cotton, the seed hairs of which constitute the purest major source in nature. Cellulose may also be present in bacterial, fungal, and algal species, and even a few animal species (Ward and Seib 1970).

Structure

Cellulose can be regarded as a polymer of glucose formed by condensation through the removal of water molecules. It may well be that cellulose, and other polysaccharides such as starch, are synthesized from glucose in plants according to the equation (Urbanski 1964):

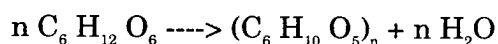

Specifically, cellulose is regarded as an unbranched polymer of D-anhydroglucopyranose units linked by B-1,4-glucosidic bonds (Jorgensen 1950; Dorée 1950; Ward and Seib 1970; Krassig 1985; Franz and Blaschek 1990). Another polysaccharide similar to cellulose is starch. Starch differs from cellulose only in the spatial configuration of the oxygen bond (glucosidic bond): this linkage joins the carbon atoms 1 and 4, which occupy the B--position in cellobiose, and the a-position in maltose. Figure 1 shows the molecular relationship between glucose, starch, and cellulose.

The molecular weight of cellulose varies between 50,000 and 2,500,000 depending on the origin of the fibers. Dividing by the molecular weight of one repeating unit (~162 amu) obtains the degree of polymerization (DP), ranging from 300 to 15,000. However, because isolation of the cellulose almost always results in degradation of the cellulose structure, these variations may be slightly exaggerated (Ward and Seib 1970; Franz and Blaschek 1990). Table 1 gives data for the molecular weight of cellulose of various origins determined by ultracentrifuging cuprammonium hydroxide solution ($\text{Cu}(\text{NH}_3)_4^{2+} \text{OH}_2^{2-}$).

Table 1. Molecular weight of cellulose from Urbanski (1964).

	Molecular weight	Degree of polymerization	Reference
Unbleached cotton	1,500,000	9200	Gralen and Svedberg (1943)
Purified linters	1,500,000-500,000	10,000-3000	Kraemer (1938)
Nettle fiber	1,760,000	10,800	
Ramie fiber	1,840,000	11,300	Gralen and Svedberg (1943)
Sulfite - pulp	400,000	2900	

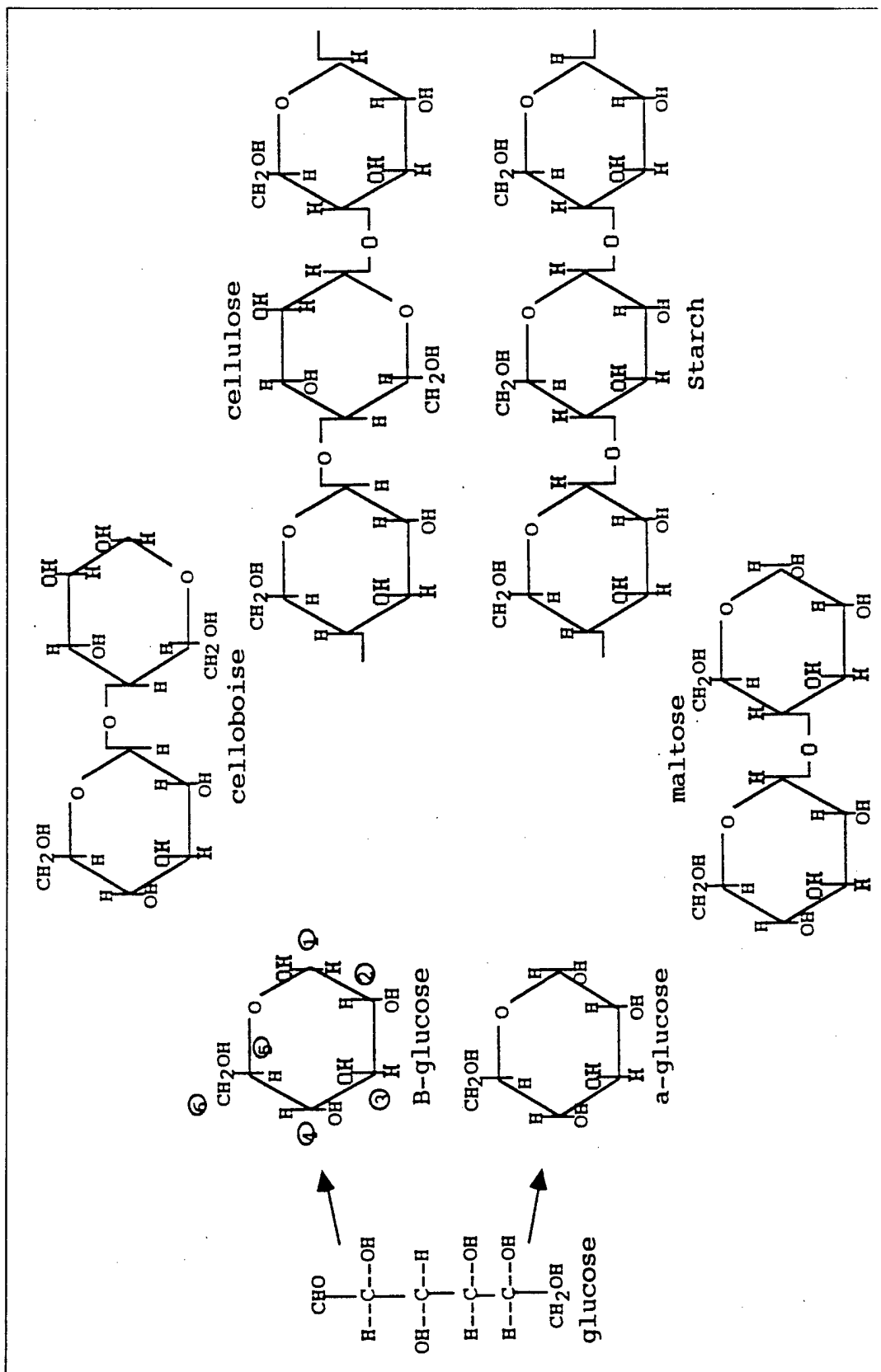

Figure 1. Molecular relationship between glucose, starch, and cellulose.

Properties

The chemical character and properties of the cellulose molecule are determined by the sensitivity of the H-glucosidic linkages between the glucose repeating units and by the presence of three reactive hydroxyls, namely one primary hydroxyl and two secondary hydroxyls in each of the repeating units. These reactive hydroxyl groups are able to undergo substitution reactions, such as etherification and esterification. The presence of these hydroxyl groups also provides cellulose with hydrophilic properties. The esters of cellulose are appreciably less hygroscopic. Their hygroscopicity decreases as the number of ester groups increases, though esterification does not totally eliminate hygroscopicity.

The sorption of water by cellulose is accompanied by swelling of the structure. X-ray patterns of cellulose I do not change on wetting. This indicates that the observed swelling is due to water uptake in the disordered regions of the structure (Ward and Seib 1970).

Alkali cellulose is unstable and easily hydrolyzes in water, therefore the sodium hydroxide can be completely removed by washing with water. This results in swollen cellulose (mercerized cellulose). In the past, this swollen cellulose was called hydrated cellulose. Cellulose hydrate is more hygroscopic than cellulose and demonstrates increased reactivity. In certain cases, such as treatment with cuprammonium, swelling is so extensive that the cellulose dissolves.

In contact with hydrolyzing or oxidizing agents, cellulose undergoes hydrolysis, or oxidation accompanied by hydrolysis, to form hydrocellulose or oxycellulose. Hydrocellulose is formed when pure cellulose is subjected to treatment with cold mineral acid solutions. Hydrolysis proceeds in stages to finally yield glucose. The initial hydrolysis is mainly confined to the amorphous fraction of the cellulose structure. By stopping the hydrolysis during the reaction, hydrocellulose in the form of nondissolved fibers or as powder can be produced (Dorée 1950; Miles 1955).

The changes that occur during the production of hydrocellulose all follow from the destruction of the 1,4-glucosidic bonds. The cellulose chains are thus shortened during the reaction resulting in a decrease in their average molecular weight. Cellulose fibers tend to lose tensile strength and elasticity as a result of this treatment, while also becoming partially soluble in sodium hydroxide solutions.

Oxycellulose is formed by the action of oxidizing agents such as hypochlorite solutions or hydrogen peroxide. The properties of the resulting oxycellulose depend on the method of preparation. Oxycellulose prepared in neutral or acid solutions exhibits reducing properties that indicate the presence of aldehyde groups. Oxycellulose prepared in an alkaline medium exhibits acidic properties owing to the presence of carboxylic groups. As with the hydrocelluloses, oxycellulose is also partially soluble in sodium hydroxide, and exhibits a decrease in the tensile strength of the fibers over its parent material (Dorée 1950; Miles 1955).

Nitrocellulose Structure and Properties

Cellulose nitrates, commonly known as nitrocellulose (NC), refer to a variety of compounds containing various amounts of nitrogen bound to a backbone cellulose structure. As previously discussed, hydroxyl groups on the cellulose monomer enable it to be esterified up to a maximum of three ester groups to every anhydroglucose unit. This esterification is accomplished using various ratios of sulfuric acid, nitric acid, and cellulose. These ratios will dictate the degree of esterification, as well as the nitrogen content, of the final product. The esterification reaction of cellulose with nitric acid can be expressed by means of the following equation:

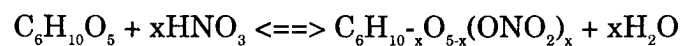

The cellulose formula in this equation is simplified by assuming the degree of polymerization (DP) equals one.

The nitration of cellulose, like all esterification reactions, is a reversible reaction under equilibrium conditions. Therefore the reverse reaction, hydrolysis, can take place although to a very small extent. In addition to hydrolysis, a series of side reactions also take place resulting in the formation of various by-products.

A cellulose in which only one hydroxyl group is replaced by a nitrate would be referred to as cellulose mononitrate. Likewise, replacement of two and three hydroxyl groups would be referred to as cellulose dinitrate and cellulose trinitrate, respectively. The maximum percent of nitrogen by weight that the cellulose can contain is 14.15 percent in the trinitrate form. Nitrocellulose with nitrogen contents of 11.12 and 6.76 percent occur in the dinitrate and mononitrate forms, respectively.

Commercially produced nitrocellulose may have all the possible number of NO_2 groups, from zero to 3, including the fractional ones. A sample of NC thus does not contain one individual compound, but a mixture of several products. It will vary in the degree of polymerization as well as in the degree of substitution.

The nitrogen content determines the energetic properties of NC. The more nitrogen attached, the more oxygen is available for the oxidation of the molecule. The highly nitrated forms of NC containing 12.3 to 13.5 percent nitrogen by weight are required for military use because of their extremely high energy properties. For military purposes, two major types of NC are distinguished (Quinchon and Tranchant 1989): CP1, which is insoluble in ether-alcohol mixtures and has a nitrogen content between 12.8 and 13.5 percent; and CP2, which is soluble in ether-alcohol mixtures and has a nitrogen content generally between 12.3 and 12.8 percent. Nitrocellulose with nitrogen contents below approximately 12.3 percent is usually used in industry in the manufacture of such things as lacquers and artificial leathers.

Structure

The degree of polymerization (DP) of the NC is determined by the number of anhydro-glucose monomers contained in the macromolecule. The degree of polymerization of the NC is always lower than the degree of polymerization found in the parent cellulose used in its production. NC with DP values on the order of 100 to 2000 is not uncommon. This observed reduction in the size of the cellulose macromolecule can be attributed to acid hydrolysis that takes place during the initial nitration of the cellulose. Figure 2 shows the molecular structure of a nitrocellulose macromolecule as it would exist in the theoretical trinitrate form.

Based on this structure, the following nomenclature has been developed, Table 2, taking into account the average number of (ONO_2) -groups attached to one anhydroglucose ring (Urbanski 1964):

As with cellulose, insight into the crystalline structure of NC came about through the use of X-ray investigations. Mathieu (1933) determined that trinitrocellulose crystals belong to the orthorhombic system, the dimensions of the crystal cell being: $a = 12.40 \text{ \AA}$, $b = 25.4 \text{ \AA}$, $c = 9.0 \text{ \AA}$, angle $B = 90$ degrees. Later investigations conducted by Trommel (1959) found that nitrocellulose exists in two structural forms: (1) An intermediate structure characterized by cell dimensions $a = 13.81 \text{ \AA}$, $b = 10.45 \text{ \AA}$, $c = 7.92 \text{ \AA}$, angle $B = 90$ degrees. This structure closely resembles that of cellulose and a few cellulosic structural elements are present. This structure exists between 12.3 and 13.2 percent

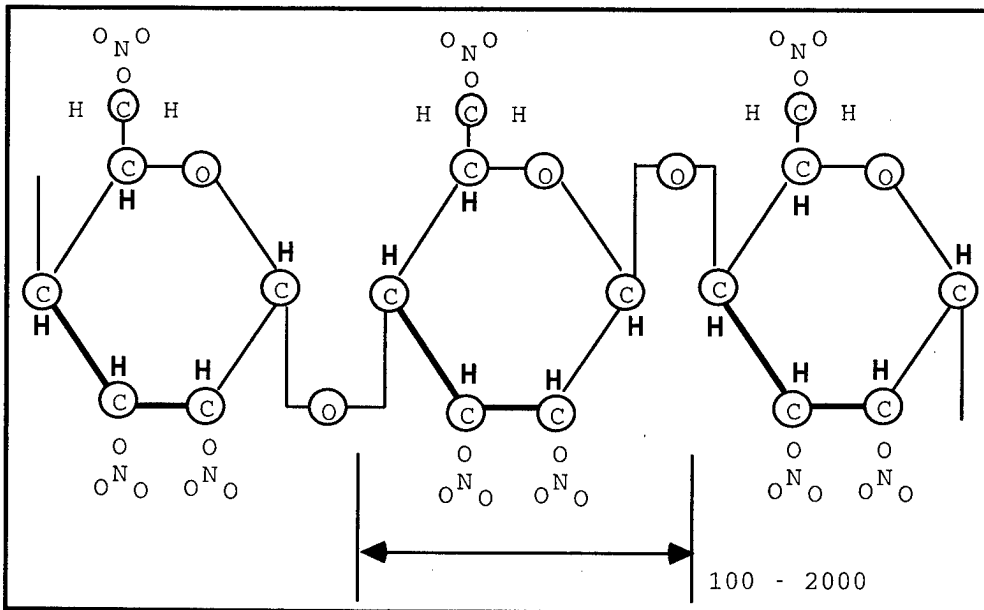

Figure 2. Molecular structure of NC (theoretical "trinitrate" form).

Table 2. NC molecular formula.

		MW	%C	%N
cellulose trinitrate	$C_6H_7O_2(ONO_2)_3$	297	24.2	14.14
cellulose dinitrate	$C_6H_8O_3(ONO_2)_2$	254	28.4	11.12
cellulose mononitrate	$C_6H_9O_4(ONO_2)$	207	34.8	6.76

nitrogen; (2) A trinitrate structure with cell dimensions $a = 12.94 \text{ \AA}$, $b = 25.66 \text{ \AA}$, $c = 8.92 \text{ \AA}$. The chain molecules in this case being parallel to the b - axis (Urbanski 1964).

Other less substituted forms of NC, such as commercial grades, are considerably less crystalline than their cellulose source. Miles and Craik (1930) found that three classes or phases of crystallinity appeared during the nitration of the cellulose molecule (Miles 1955; Urbanski 1964):

- NC containing less than 7.5 percent nitrogen, which show a fiber character and give no X-ray diffraction indicating nitration, but do give the pattern of mercerized cellulose.
- NC containing between 7.5 and 10.5 percent nitrogen. This NC is for the most part disintegrated. The diffraction patterns observed are very diffuse owing to the small crystalline elements of mercerized cellulose.
- NC containing more than 10.5 percent nitrogen. This is the first class to exhibit a true crystalline character. As the nitrogen content continues to increase above this value the crystalline character of the structure increases. At 12.8 percent nitrogen, the characteristics of trinitrocellulose are observed.

Properties

Many of the physical and chemical properties of NC are dependent on the degree of nitration of the parent cellulose. The specific gravity of NC is one of those properties affected by the degree of nitration. Petitpas and Mathieu (1946) reported that the specific gravity of NC in water ranged from 1.654 to 1.662 for NC with nitrogen contents of 11.52 to 13.1 percent, respectively, while that of native cellulose is approximately 1.58. This range of specific gravity values agrees closely with those obtained by other investigators.

Solubility is also an important property. The solubility characteristics of the NC are determined by two major factors: the nitrogen content and the distribution of the nitrate groups. NC will dissolve in many organic solvents, e.g., acetone, acetic esters, and ether-alcohol. Table 3 summarizes the solvents used to solubilize NC of varying grades.

Because NC is usually used in the form of colloidal solutions, solubilization is an important step in the manufacture of many NC products. The principal characteristics of these solutions are: (1) the dissolved substance can be precipitated, with difficulty, from the dispersing phase; (2) prior to dissolution the substance undergoes extensive swelling; (3) viscosity of the colloidal solutions is high, even if the concentration of NC is low; and (4) the substance does not form saturated solutions in a single solvent (Urbanski 1964).

The solubilization of NC is due to the separation of the chains of the macromolecules under the influence of the solvent until all the bonds between the chains disappear. This solubilization may not take place in certain cases (i.e., very low or very high nitrogen NC), the action being limited to the production of swelling. Two possible mechanisms explain this phenomenon. First, the hydroxyl groups are substituted with nitrate groups to a very small extent. As a result of this, the constitution of the chains is regular enough to ensure the formation of hydrogen bonds that will link the chains together. Second, all the hydroxyl groups are replaced by nitrate groups, as in trinitrocellulose, giving a regular structure to the chains. Intermolecular forces, such as Vander Waals forces, will keep the chains together, thus possibly preventing the solvent from separating them.

Table 3. Solvents used for various NC grades from Dorée (1950).

10.7-11.2 % nitrogen	Soluble in alcohol
11.2-11.7 % nitrogen	Soluble in methyl+ alcohol, ether-alcohol, ethyl acetate, acetone and other solvents.
11.8-12.3 % nitrogen	Soluble in ethyl, butyl and amyl acetates, ether-alcohol and acetone. Insoluble in ethyl alcohol.
12.4-13.0 % nitrogen	Partially soluble in the usual solvents but completely soluble in acetone.

The hygroscopicity of NC is another property that has been studied in detail. Will (1904) determined that a distinct relationship existed between the nitrogen content of the NC and the amount of moisture absorbed (Miles 1955; Urbanski 1964). This can be explained by the fact that, as the number of nitrate groups on the molecule increases, the number of hydroxyl groups available for hydrogen bonding decreases, thus decreasing the amount of water that can be absorbed.

The stability of NC is probably the property of greatest concern, especially in those industries that use highly nitrated materials. The turning point in the field of stabilizing NC was reached when Abel (1868) discovered that a certain amount of acid, retained within the fibers, was causing the instability of the nitrocellulose. According to Abel, stable nitrocellulose could be produced by subjecting the fibers to a prolonged period of boiling in water (Urbanski 1964). It has since been shown that NC's resistance to thermal decomposition is directly dependent on the composition of the acids used in its production (i.e., sulfuric and nitric). Specifically, when the nitrating mixture contains a high concentration of sulfuric acid, the thermal stability of the resulting product is reduced. This poor stability has been attributed to the formation of sulfuric acid esters in the NC as a result of incomplete nitration.

In addition to its thermal instability, nitrocellulose exhibits a poor resistance to acids. Treatment of NC in dilute acids and bases results in denitration of the ester, while treatment in concentrated sulfuric acid results in complete solubilization. Treatment in concentrated caustic solutions produces saponification accompanied by the destruction of the polymeric bonds.

Treatment Alternatives for Nitrocellulose Wastes

As discussed in the introduction, waste streams containing nitrocellulose fines are generated during NC manufacture. Historically, most resources have gone into research on nitrocellulose production, while few resources have been devoted to the treatment and disposal of these waste materials. With the onset of new environmental regulations, these wastes have come to be listed as hazardous wastes, not only due to their manufacturing source, but also because of their explosive characteristics, thus making many traditional treatment methods unacceptable or prohibitively expensive. For this reason, various technologies have been investigated for the separation and treatment of these wastes from the process waste streams.

Separation Technologies

Separation of nitrocellulose fines from process wastewater streams can be applied as a treatment technology in itself, or as a pretreatment step followed by chemical or physical alteration of the concentrated material. In cases where chemical or physical alteration of the nitrocellulose is proposed, concentration of these materials is a vital first step in making any such technology economical. Separation methods looked at in recent studies include sliding bowl centrifugation, solid bowl centrifugation, pressure filtration, new decanters, and microfiltration (Kim and Park 1993).

In 1987, Arthur D. Little, Inc. was contracted by the U.S. Army Toxic and Hazardous Materials Agency (USATHAMA) to perform an engineering and cost evaluation for the separation and treatment of these nitrocellulose wastes at the Radford Army Ammunition Plant (RAAP) in Radford, VA.

Arthur D. Little, Inc. (Balasco 1987) evaluated the performance of both sliding bowl and solid bowl centrifuges at RAAP. Pilot scale evaluations using DeLaval sliding bowl centrifuges, installed for the purpose of clarifying the poacher pit water, showed promise. However, continuous operation of these centrifuges proved to be unreliable due to inconsistencies in particle removal efficiency, and the accumulation and sticking of solids to the bowls of the centrifuges. Solid bowl centrifuges were also evaluated as a means to further concentrate the waste stream that had been preconcentrated by the sliding bowl centrifuges. It was anticipated that such a secondary concentration step would yield sludge containing 20 to 25 percent NC solids. The solid bowl centrifuges operated in this manner also failed to perform adequately. This was due to the failure of the sliding bowl centrifuges to sufficiently preconcentrate the waste stream.

Conventional pressure filtration was considered as a separation technique to remove the water, and thus concentrate the NC fines. However, due to the small size of the NC particles, conventional filtration equipment retained less than 10 percent of the NC particles from the waste stream. Various filters and filter aids were tested to try to improve the removal efficiency of the filtration equipment, but all failed to yield adequate separation (Balasco 1987).

The cross-flow microfiltration/ultrafiltration differs from conventional dead-ended filtration in that the process waste stream is continually swept past the filtering surface so that a static layer of solids is not formed on the filter. Cross-flow microfiltration applied to the poacher settling pit overflow directly (without any preconcentration) resulted in a nitrocellulose concentration approximately 1000 times the original concentration (Balasco 1987). Despite such problems as

cake of the membrane surface, biofouling, and energy consumption, cross-flow microfiltration was thus recommended by Arthur D. Little, Inc. as the most attractive separation/concentration option evaluated. USACERL evaluated the effectiveness of a cross-flow microfiltration with hollow fiber membrane and achieved a marginal success due to clogging of membrane with larger particles (Kim et al. 1995). The irreversible fouling effects on the various microfiltration/ultrafiltration membranes were compared on bench scale cross-flow microfiltration/ultrafiltration systems (Kim et al. 1996). A pilot scale cross-flow microfiltration/ultrafiltration was recommended as a pollution prevention measure (Kim et al. 1995).

Treatment Technology

As with the separation/concentration technologies just discussed, numerous technologies for the treatment or ultimate disposal of these separated nitrocellulose fines have been studied. Balasco (1987) evaluated two such processes: incineration and alkaline hydrolysis.

Incineration is a proven technology for the disposal of munitions wastes, and has been employed at the RAAP in the past. The study evaluated both direct-fired combustion and indirect-fired combustion incinerators. The author determined that concentration of the waste nitrocellulose was a critical aspect in making incineration an economical alternative. For this reason NC sludges with solids contents ranging from 10 to 25 percent were evaluated. Results of this evaluation showed that incineration, while being an acceptable technology, was a very expensive option in comparison with alkaline hydrolysis (Balasco 1987).

Alkaline hydrolysis was also evaluated as a means of degrading the nitrocellulose. This treatment resulted in complete and rapid solubilization of the particulate NC, resulting in a hydrolysate that was substantially biodegradable. Alkaline hydrolysis was subsequently determined to be the most flexible and cost effective alternative for the treatment of the NC fines (Balasco 1987). A detailed discussion of the hydrolysis process, and in particular alkaline hydrolysis of nitrocellulose, is presented in the subsequent sections.

Numerous other treatment alternatives for the disposal of these wastes have also been investigated, including: UV laser irradiation (Yang and Ramsey 1993); aerobic microbial degradation (Gallo et al. 1993); anaerobic biotransformation (Duran et al. 1993); acid hydrolysis followed by anaerobic digestion (Hsieh and Tai 1993); and composting (Lowe 1993).

Hydrolysis Reactions

As shown in the previous section, the processing and disposal of waste products from the manufacture of NC has become an important environmental, as well as economic issue. Ordinarily, such organic residues would be subjected to some form of biological treatment. However, due to the high degree of substitution found in the military grade NC, and the corresponding high degree of crystallinity and subsequent inaccessibility of the molecules, these substances have proven to be resistant to this conventional direct biological approach.

It has been reported that the rate limiting step in any biological treatment system is the breakdown of the particulate organic matter to soluble substrate (Eastman and Ferguson 1981; Pavlostathis and Gossett 1986; Han and Callihan 1974). Slowly biodegradable or nonbiodegradable macromolecules such as NC must typically be acted on extracellularly and converted to smaller, more readily biodegradable units. The process usually involves increasing the surface area available for microbial attack and/or altering the chemical structure of the molecule. This breakdown is generally referred to as hydrolysis and can be brought about by thermal, acid, or alkali treatment. If one wishes to improve the efficiency of the subsequent biodegradation and/or reduce the amount of residual solids requiring disposal, the first step is thus to increase the rate of this hydrolysis. Several studies dealing with the acceleration of hydrolysis reactions have been reported in the literature.

General

In most cases, this hydrolysis has been applied to hydrolyse biological cells in sludges, thereby releasing soluble organic matter held within the cell wall. The larger cellular molecules are also solubilized, further increasing the release of soluble organic material. Applied in this manner, the hydrolysis acts to increase the rate of subsequent biodegradation of waste sludges, and thus speed sludge stabilization, by making more of the organics available for biochemical uptake and oxidation. The chemical pretreatments used in this study included the addition of $\text{Ca}(\text{OH})_2$, NaOH and HCl to concentrations of 300 meq/L. HCl increased the extent of hydrolysis significantly, while NaOH only resulted in a slight increase. Except in the case of $\text{Ca}(\text{OH})_2$, chemical addition also improved the subsequent biodegradability.

Stuckey and McCarty (1979) examined the effect of thermochemical pretreatment of waste activated sludge on aerobic biodegradation. The authors found that heating the WAS to temperatures between 150 and 250 °C increased

the soluble COD to 40 to 60 percent of the total. Subsequent digestion studies demonstrated that soluble COD biodegradation increased accordingly.

Hiroka et al. (1984) analyzed molecular size distributions in thermally pretreated sludges using gel chromatography. The resulting chromatograms showed that thermal pretreatment caused a peak shift from a higher to a lower molecular size region. This shift appeared to be caused by the depolymerization of organic matter such as fats and carbohydrates to soluble intermediates.

Finally, Mukherjee and Levine (1992) studied the hydrolysis of an industrial waste high in particulate organic content. They suggested that chemical solubilization as a pretreatment method may provide a more efficient means of solubilizing the particulates to a usable form than that provided by the natural enzymatic hydrolysis that takes place in a bioreactor. In their studies, particular emphasis was placed on hydrolysis using sodium hydroxide. The rationale behind the use of an alkali, instead of an acid, is that residual alkalinity is compatible with biological treatment, while acidity is not. Results of this study showed that both carbohydrates and proteins could be efficiently solubilized by alkaline hydrolysis in a relatively short time period. Soluble TOC increased by 16.2 percent following 2 hours of digestion. In addition, the biodegradability of the remaining solid phase was substantially increased.

While all of these investigations, excluding the latter, dealt with thermal and chemical hydrolysis of biological sludges, these same concepts can be applied to the degradation of other organics not susceptible to direct microbial attack. In particular, chemical hydrolysis of cellulose and nitrocellulose will be thoroughly reviewed.

Cellulose

Acid Hydrolysis. The acid hydrolysis of lignocellulosic materials is by far the most commonly practiced engineered hydrolysis reaction used by industry. The process is used to produce liquid fuels, food, and chemical feedstocks.

When a homogenous cellulose sample (i.e., relatively pure cellulose with little hemicellulose or lignin) undergoes acid hydrolysis, the B-1,4-glucosidic bonds of the cellulose fiber are split by the addition of water molecules; this addition results in depolymerization of the cellulose while preserving its basic structure.

Hydrolysis of cellulose in concentrated acids proceeds through the formation of cellulose acid complexes. These complexes are formed only after the crystalline structure has been destroyed through dissolution or swelling of the structure.

The reaction then proceeds through oligosaccharides to glucose. Hydrolysis with hot dilute acid proceeds through the formation of hydrocellulose to soluble polysaccharides and then to glucose.

According to Fan et al. (1987), the hydrolysis can follow two different paths, with protonation of the cyclic oxygen, the glucosidic oxygen, or both. The end result of either reaction is the formation of D-glucose. Belkacemi et al. (1991) found that, in the case of a heterogeneous reaction (i.e., acid hydrolysis of lignocellulosic material), the reaction mechanisms described by Fan et al. are still likely to be valid, but the measured rate of the glucosidic bond cleavage is generally lower.

The kinetics of acid hydrolysis of pure cellulosic substrates has been the subject of a number of studies. Saeman (1945) and Grethlein (1975) depict the acid hydrolysis process as a pseudo-first-order sequential process, with the rate constants as a function of the acid concentration raised to a power, i.e.:

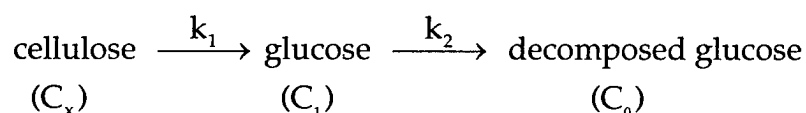

$$\frac{dC_x}{dt} \Rightarrow -k_1 C_x$$

$$\frac{dC_1}{dt} \Rightarrow +Y_1 k_1 C_x - k_2 C_1$$

$$\frac{dC_0}{dt} \Rightarrow +Y_2 k_2 C_1$$

where:

$$k_1 = K_1 (A)^m \exp (-E_1/RT)$$

$$k_2 = K_2 (A)^n \exp (-E_2/RT)$$

In these expressions, C_x = concentration of cellulose, C_1 = concentration of glucose, C_0 = concentration of decomposed glucose products, k_1 and k_2 are the rate constants for the respective reactions, Y_1 and Y_2 are the stoichiometric coefficients, A is the acid concentration, K_1 and K_2 are the frequency factors, and E_1 and E_2 are the activation energies. The values of these constants were then estimated for several different substrates. Table 4 lists these values.

Table 4. Acid hydrolysis constants for various cellulosic materials from Humphrey (1979).

Constant	Douglas Fir	Cellulose	Solka Floc
K1, min ⁻¹	1.73 x 10 ¹⁹	1.57 x 10 ¹⁴	1.22 x 10 ¹⁹
K2, min ⁻¹	2.38 x 10 ¹⁴		3.79 x 10 ¹⁴
E1, cal/g - mol	42,900	34,000	42,500
E2, cal/g - mol	32,800		32,700
m	1.34	1.42	1.16
n	1.02		0.69

Alkaline Hydrolysis. Alkaline hydrolysis of lignocellulosic materials has been practiced in the pulp and paper industry for years. The Kraft pulping process uses high strength sodium hydroxide at relatively high temperatures (~170 °C) to remove lignin and short chain hemicelluloses from the lignocellulosic raw material. This results in a relatively pure, although slightly altered and depolymerized, cellulose. While this is not the intention in the paper industry, this hydrolysis results in a significant increase in the susceptibility of the cellulose to biodegradation. This increase in biodegradability is believed to be due to the removal of the protective lignin shield, thus making the structure more susceptible to enzymatic attack.

The course of this alkaline degradation can be explained by means of three degradation mechanisms: (1) swelling of the cellulose structure, (2) alkaline hydrolysis of the glucosidic bonds; and (3) peeling off and stop reactions (Blazej and Kosik 1985; Fan et al. 1987; Hon and Shiraishi 1990; and Mukherjee and Levine 1992).

As stated earlier, swelling of the cellulose fiber occurs readily under the influence of aqueous sodium hydroxide. Under certain severe treatment conditions, these solutions can cause dissolution of the fibers. The exact mechanism taking place on dissolution is not known, but is most likely related to the bond strength holding the fibers together.

The second reaction, hydrolysis of the glucosidic bonds, occurs in the same manner as in acid hydrolysis, including the statistical fragmentation of chains and the formation of reducing terminal groups (Blazej and Kosik 1985). These reducing terminal groups give rise to the third reaction, the peeling process. During the peeling reaction, terminal monomeric units are peeled off, forming isosaccharinic type acid. According to Hon and Shiraishi (1990), the overall process is controlled by the competing peeling and stopping reactions, the stopping reaction being the formation of terminal metasaccharinic acid; and is significantly affected by the type and concentration of the alkali, and the reaction temperature. The accessibility of the cellulose, or more specifically, the terminal reducing groups, thus determines the extent of the peeling reaction.

Nitrocellulose

Acid Hydrolysis. Acid hydrolysis of cellulose has been the subject of countless investigations. As a result, much is known about the mechanisms involved in the reaction. Acid hydrolysis of nitrocellulose is a far more difficult subject, however, because the reaction appears to be much more complex.

It has been suggested that NC dissolves in concentrated sulfuric acid. At the same time, the NC slowly loses nitric acid resulting in the formation of a sulfuric ester. In concentrated nitric acid, dissolution only occurs when the mixture is heated to 80 to 90 °C. Treatment in more dilute nitric acid results in very slow and partial denitration of the NC without the associated solubilization. This results in the formation of oxycellulose (Urbanski 1964).

Miles (1955) believed that the reactions occurring on acid treatment of NC, include: (1) deprotonation of the nitrate ester, returning the original acid and cellulose; (2) chain division by the fission of glucosidic bonds; and (3) breaking off of nitrite groups as occurs in the thermal decomposition of NC. Miles suggested that all three reactions are always proceeding, but that denitration and deprotonation are very slow as long as only slight depolymerization has occurred. As the degree of polymerization decreases, nitrate oxidation becomes the predominant reaction, breaking down and finally destroying the chain molecule.

Lure et al. (1991) studied the denitration and the hydrolysis of NC under the action of 0.2 to 60 percent sulfuric acid. The rate of denitration was determined by measuring accumulation of HNO_3 in the aqueous phase, while hydrolysis was determined by changes in the viscosity of the solution. Secondary redox transformations were also found to be significant. The kinetics of these redox reactions were determined from the measurement of oxidation and reduction products in the evolved gas. Results of this study showed that the hydrolysis of nitrocellulose is approximately three orders of magnitude slower than the corresponding hydrolysis of cellulose. In addition, the dependence of the hydrolysis reaction on the acid concentration is much lower than the dependence of the associated denitration reaction. Both reactions appear to follow first order kinetics. The authors also found that the HNO_3 accumulated on hydrolysis in the presence of easily oxidized NC functional groups has a restricted life. Its decomposition is accelerated with the appearance of HNO_2 and NO . At a specific stage of acid hydrolysis, accelerated evolution of gases in the form of HNO_3 reduction products (NO , N_2O , N_2) and the oxidation of organic compounds (CO , CO_2) takes place. Finally, it appears that the degradation of the NC on acid hydrolysis is much slower than the corresponding denitration.

Hsieh and Tai (1993) studied the acid hydrolysis of nitrocellulose using concentrated hydrochloric acid. In this study, concentrated hydrochloric acid was reacted with various quantities of NC at temperatures of 50 to 100 °C. The reaction was allowed to proceed until the nitrocellulose was completely dissolved. The resulting liquor was then diluted and boiled for an additional 1 to 5 hours. The boiling was conducted to prevent further decomposition of any glucose formed. The results of this study showed that glucose was the dominant species in the final solution. Other products formed included citric, formic, oxalic, malic, pyruvic, succinic, glycolic, and adipic acids. Depending on the reaction time, sugar conversion ranged from 30 to 99 percent. From the nitrite and nitrate concentrations measured in the hydrolysate, it was suggested that during the hydrolysis process, O-NO₂ bonds are first cleaved to form nitrite. Nitrite was then further converted to nitrate or ammonia. The results obtained in this study, while preliminary, are very encouraging in that the glucose conversion levels claimed, are much higher than those obtained in other studies using either acid or alkaline hydrolysis of nitrocellulose.

Alkaline Hydrolysis. Originally developed in the middle of the 19th century, the strategy of alkaline hydrolysis for the degradation of nitrocellulose has been the subject of numerous investigations. This process uses high strength alkalis to depolymerize the nitrocellulose into carbon chains of varying lengths and varying degrees of substitution. As with the other hydrolysis reactions discussed in the preceding sections, this reaction has been found not to be one of simple saponification regenerating the alcohol and forming sodium nitrates, but a complex decomposition. Some of the degradation products as claimed by the earliest researchers and summarized by Kenyon and Gray (1936) include: inorganic nitrites and nitrates, ammonia, cyanide, carbon dioxide, oxalic, malic glycolic, trioxylglutaric, dioxybutyric, malonic and tartonic acids, sugars, modified cellulose, and partially denitrated cellulose nitrates. These degradation products are quite similar to those claimed to be present as a result of acid hydrolysis of nitrocellulose.

Kenyon and Gray's (1936) investigation was, for the most part, the first quantitative study of the alkaline hydrolysis of NC. Lacking evidence of prior extended studies on the quantitative decomposition of cellulose nitrate, the authors studied the effect of certain variables: alkali concentration, ratio of alkali to ester, time, temperature, and degree of nitration of the cellulose.

In these experiments, NC was first dried and weighed. Samples were placed in flasks with the amount of water that would yield the desired final concentration. These aqueous suspensions were placed in a large water bath and allowed to come to temperature equilibrium. Alkali was then quickly added with shaking.

The flasks were closed with rubber stoppers and placed in the bath until the decomposition was complete, as evidenced by the disappearance of the suspended cellulose nitrate. The experiments were conducted at two temperatures of digestion (30 and 60 °C), five alkali concentrations (1, 2.5, 5, 10, and 20 percent NaOH, weight to volume), digestion times ranging from 0.5 to 1104 hours, and variations of the ratio of alkali to NC. All samples were analyzed for: carbon dioxide, optical rotation, nitrites, and reducing power (which was compared with the reducing power of glucose).

The results of Kenyon and Gray's work showed that NC, when decomposed by aqueous sodium hydroxide solutions, yielded alkali soluble products (among which was carbon dioxide). This oxidative decomposition of the cellulose molecule was accompanied by reduction of the nitrate to nitrite groups. The time required to decompose a given weight of NC decreased with increasing temperature and alkali concentration, but was independent of the alkali-NC ratios at constant concentration. In addition, it was observed that, during the reaction, the color of the liquid became reddish-brown. This color change appeared to be similar to that observed with the caramelization of sugar. This same color is observed in the "Black Liquor" of modern pulping operations using the Kraft process.

In later work by Miles (1955), reference was again made to hydrolysis of NC by alkaline reagents. In this work, the author found (as did the previous authors), that complex changes occur during the reaction, various oxidation products appeared, and the nitrate radical was converted into the nitrite ion. Miles also reviewed acid hydrolysis of NC. He observed that, while the caustic hydrolysis reaction was much faster than the acid hydrolysis reaction, both resulted in similar decomposition products. He concluded that, in either case, the fundamental factor was the oxidizing power of the nitrate groups, exerted on the rest of the pyranose ring in such a way that even alkali is unable to inhibit it. It was also found that, under reducing conditions, this extensive breakdown of the structure was greatly reduced while the denitration reaction was unaffected.

In addition, the author found that denitration of NC always caused a corresponding degradation of the structure, which was accompanied by a marked loss of viscosity even when reducing reagents were used. This loss of viscosity was greater for NC of high nitrogen content and less for NC of low nitrogen content. It was observed that this loss of viscosity always increased with the viscosity of NC. Thus, there was a tendency on denitration to reduce all molecular lengths to a relatively low common value.

In an effort to shed light on the mechanisms involved in the decomposition of the NC, Miles looked to the work of earlier researchers. These works suggested that the method employed to originally nitrate the cellulose held the key to the degradation that takes place on denitration. It was suggested that the celluloses submitted to the action of neutral or acid oxidizing solutions have in their chain molecules certain linkages that are unstable to alkali, and under its influence can be broken, so that fission of the chain occurs. Hydrocelluloses, formed by treatment with non-oxidizing acids, such as hydrochloric, do not contain such labile linkages. Alkaline oxidized celluloses may contain these linkages, and if so, the alkali employed would break them.

Jackson and Hudson (1936) found that, when oxidized cellulose was treated with periodic acid, a dialdehyde compound was formed at carbon atoms (2) and (3). No formic acid was produced during the reaction, for when the oxidized cellulose was hydrolyzed with the acid, that part of the residue comprising carbon atoms 3-6 gave rise to erythrose. The authors believed that the oxidized cellulose should be more susceptible to alkaline hydrolysis than the original substance. Evans, et al. (1936) found that the corresponding disaccharide 2-glucosido-erythrose, which was regarded as an intermediate product in the alkaline degradation, was sensitive to alkali, and that it was thus likely that an oxygen linkage between an erythrose and a glucose unit in an "oxycellulose" chain might also be susceptible to alkaline hydrolysis with a subsequent reduction in the degree of polymerization. Figure 3 shows the alkaline degradation scheme proposed by Jackson and Hudson.

While the main feature of denitration was seen to be an oxidation, studies had thus far afforded only clues to the problem of how this oxidation was accomplished. The assumption that saponification first occurred and oxidation followed was not believed to be satisfactory, for it was unlikely that the nitrate ion, which would be the first inorganic product, would be reduced in dilute solution by any organic alcohol. It was therefore believed that there was some intermediate stage of reaction between the nitrate group and the hydroxyl ion.

Additional insight into the mechanisms involved was gained by Baker and Easty (1950) while working on the hydrolysis of aliphatic nitric esters. In studies carried out in polythene vessels, it was shown that the formation of an aldehyde in conjunction with nitrite ion corresponded to the hydroxyl ion used up in the reaction, after allowing for that required for the ordinary direct hydrolysis of nitrate. It was also discovered that there were three reactions that could proceed simultaneously, the organic products being alcohol, olefine and aldehyde in the different cases:

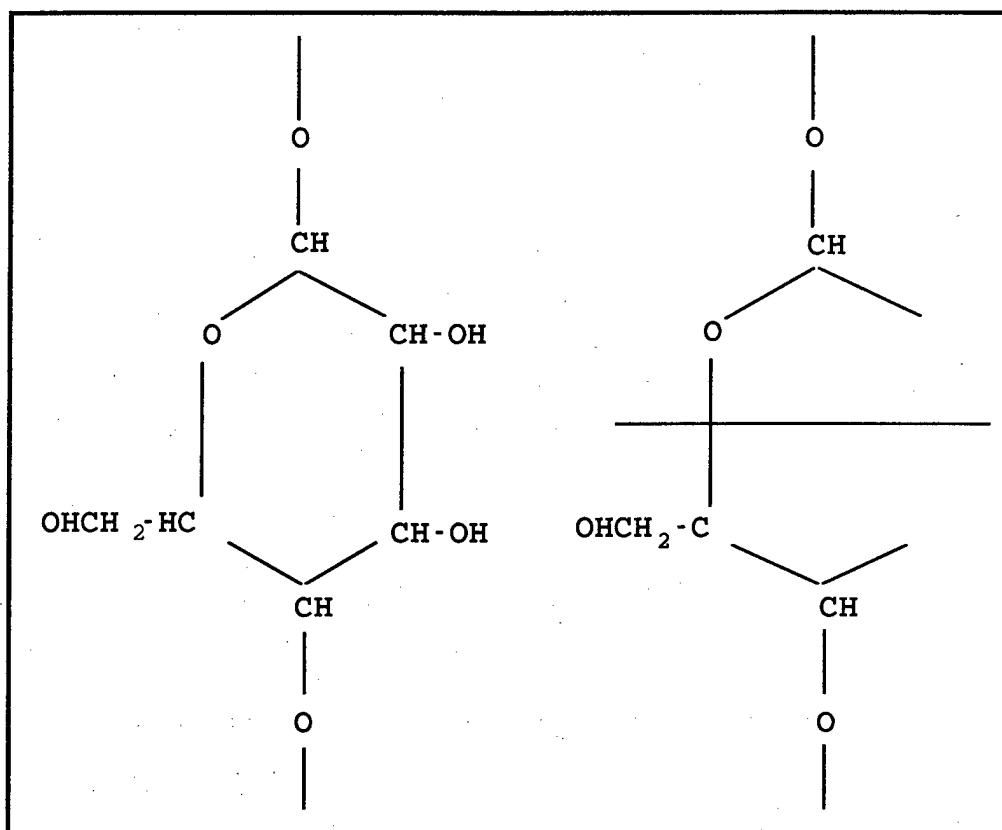

Figure 3. Alkaline degradation scheme proposed by Jackson and Hudson (1936).

- $X - CH_2 - CH_2 - O - NO_2 + H_2O = X - CH_2 - CH_2 - OH + HNO_3$
- $X - CH_2 - CH_2 - O - NO_2 = X - CH:CH_2 + HNO_3$
- $X - CH_2 - CH_2 - O - NO_2 = X - CH_2 - CHO + HNO_2$

In two of the three reactions, the nitrate molecule is broken in the usually accepted way $-C - O - NO_2$, but in the third, the rupture occurs between the oxygen and nitrogen $-C - O - NO_2$, just as in thermal decomposition.

Wendt and Kaplan (1976) reported on a bench-scale study that consisted of a combination of alkaline digestion and biological degradation for the treatment and disposal of nitrocellulose. Because cellulose substituted in even a small percentage of available side groups is not subject to attack by cellulolytic organisms, some form of modification was required to convert the highly substituted forms of nitrocellulose to biologically available substrate. Wendt and Kaplan chose alkaline hydrolysis as a feasible means of modifying the NC to support biological growth. This decision was based partly on the earlier work of Kenyon and Gray and others.

Preliminary studies were conducted by Wendt and Kaplan to determine the feasibility of the process and to help further define the mechanisms involved. In the preliminary studies, 10 g of nitrocellulose was digested in a 1.5 percent sodium hydroxide solution. Following digestions at various times and temperatures, the authors conducted elemental analyses on the various residues. Analysis of the residual solid NC following increasingly more severe hydrolysis conditions failed to show any significant change in the chemical composition as indicated by nitrogen: carbon: hydrogen percentages. Based on these findings, they determined that the hydrolysis reaction did not proceed stepwise with initial denitration followed by disruption of the cellulose backbone, but was rather an all-or-none decomposition of the entire nitrocellulose molecule.

Following their preliminary investigation, Wendt and Kaplan conducted pilot scale studies where digested, neutralized NC was fed directly to a series of biological reactors. In these tests, 20 g of NC (12.6 to 13.4 percent nitrogen) were hydrolyzed in 400 ml of 3 percent NaOH while stirring and heating at 95 °C. The reaction was allowed to proceed for 30 minutes, at which time the hydrolysate was neutralized with concentrated sulfuric acid and cooled to ambient temperature. This solution was then diluted to 2 L. The final solution contained ~1650 mg/L nitrate.

While many of the chemical analyses conducted during their investigation were not published, thus preventing direct comparison with previous results, the authors' conclusion was that the alkaline digestion of nitrocellulose with heating was sufficient to enhance the biodegradation of the material, and that the subsequent biological process successfully removed nitrite, nitrate, and biochemical oxygen demand (BOD). Wendt and Kaplan obtained a patent for the process in February 1975.

Eleven years later, Balasco et al. (1987) published a conceptual overview of the potential technical alternatives for nitrocellulose degradation, of which alkaline hydrolysis was presented as a usable technology. In this work, it was suggested that rather harsh treatment with 5 percent caustic at 90 °C for 3 hours should render nitrocellulose suitable for rapid biodegradation. Although little quantitative information was given in the report, a proposed process module for the digestion was presented. A summary of the proposed process follows.

Sludge (either 10 or 25 percent solids) from a previous concentrating step (cross-flow microfiltration or solid bowl centrifugation) is continuously pumped to a conical predigestion reactor. Forty percent sodium hydroxide is metered into the reactor to sustain a 5 percent caustic concentration, while the mixture is raised

in temperature to 65 °C. The proposed tank is designed with a vertical rotating screw that provides the necessary agitation for the thick viscous slurry. The vessel is designed with a continuous bottom discharge and sized to allow for an average 1-hour residence time. The slurry is pumped from the reactor bottom to a steam jet cooker where the temperature of the mixture is raised to 95 °C. Exiting the cooker, the material is pumped through a serpentine insulated tubular reactor with a residence time of 3 hours. The material is then discharged into a receiving vessel and then pumped to a neutralization station to be mixed with acidic water from the boiling tub pits. The authors, however, emphasized the fact that this process module is just a possibility and that the optimal conditions for the actual hydrolysis are unknown.

Hirayama and Smith (1988) followed up Balasco's work by conducting a pilot scale demonstration of the operating conditions for the alkaline hydrolysis of NC fines. In their studies, two different equipment setups and two different methods were used to conduct the hydrolysis reactions. Both experiments were conducted using a constant 2 percent (weight to volume) NC density. In one of the tests, mechanical mixing was employed while in the other an air sparger system provided all necessary mixing. Alkali concentrations used were 4 and 5 percent (w/v), respectively. The temperature of the system was allowed to fluctuate with the ambient temperature during the entire testing period. This temperature ranged from ~20 to 25 °C. The hydrolysis reactions were allowed to run for ~300 hours, at which time all the NC had been solubilized as determined by visual inspection. Following hydrolysis, samples were analyzed for: nitrite, nitrate, chemical oxygen demand (COD), biochemical oxygen demand (BOD), percent of undissolved solids, total cyanide, and color. Results of these tests were plotted against hydrolysis time and compared with the results obtained during laboratory scale studies. Concentrations ranged from 5,500 to 9,000 mg/L for COD; 58.2 to 1400 mg/L for BOD; 1700 mg/L for nitrite; 1600 mg/L for nitrate; less than 0.02 percent for undissolved suspended solids and less than 0.03 mg/L for cyanide.

Finally, Nigmatullin et al. (1990) conducted studies on the saponification of another cellulose ester, cellulose acetate. The authors conducted the hydrolysis experiments at temperatures of 298-328 °K (degrees Kelvin), and pH values of 10 and 11.5. Quantification of the studies was based on the change in the concentration of acetyl groups, as determined from IR absorption spectra.

These tests showed that the saponification of cellulose acetate over the whole range of temperatures and pH values studied can be described by a first order kinetic equation. Table 5 gives the rate constant (k) and the effective activation energies (E) for two different cellulose acetate membranes.

Biological Treatment

Cellulose

The biological degradation of raw cellulose is a slow process, brought about by enzymatic hydrolysis catalyzed by cellulolytic enzymes. The enzymes responsible for this degradation are common in nature, most frequently being produced by fungi and bacteria.

During this hydrolysis, cellulose undergoes gradual depolymerization yielding progressively lower molecular weight compounds, the final product being glucose. This reaction is not unlike that of the acid and base catalyzed reactions previously discussed, with only the rate of reaction being significantly reduced.

The ability of the cellulolytic microorganisms and that of cell free cellulolytic enzymes to degrade cellulose varies with the structural features of the material. The important features of cellulose that govern their susceptibility to enzymatic degradation include (Fan et al. 1987):

- the moisture content of the fiber
- the size and diffusivity of the cellulolytic enzymes relative to the size and surface properties of the grown capillaries, and the space between the microfibrils and the cellulose molecules in the amorphous region
- the degree of polymerization
- the degree of crystallinity of the cellulose
- the nature, concentration, and distribution of substituent groups.

According to the authors, the susceptibility of cellulose to enzymatic hydrolysis is determined largely by its accessibility to cellulolytic enzymes. Direct physical contact between the enzymes and the substrate molecules of cellulose is necessary for hydrolysis to occur. Since cellulose is insoluble and structurally

Table 5. Kinetic parameters for the saponification of CA membranes.

Temp., K	$k \times 10^7, s^{-1}$		E, kJ/mole	
	pH = 10	pH = 11.5	pH = 10	pH = 11.5
298	2.0	6.2		
308	14.3	28.0	103.8	103.6
318	29.2	87.0		
328	111.0	267.5		
298	4.7	7.8		
308	10.7	18.7	68.9	70.7
318	19.2	57.2		
328	65.0	96.2		

complex, this contact can be achieved only by diffusion of the enzymes into the complex structural matrix of the cellulose. Thus, any structural feature that limits the accessibility of cellulose to enzymes will diminish the susceptibility of cellulose to hydrolysis. To illustrate this concept, a comparison between acid hydrolysis and enzymatic hydrolysis is warranted.

As discussed in the preceding section, acid hydrolysis of cellulose is rapid compared to enzymatic hydrolysis. This can, in part, be explained by the relative size of the molecules involved. Common acids used in acid hydrolysis (i.e., sulfuric and hydrochloric) have molecular weights of 98 and 36.5 amu, respectively. On the other hand, the cellulase enzyme has a molecular weight of 63,000 amu. As a result of this large size, the enzyme molecules have limited accessibility to the substrate. Hydrolysis then becomes a localized phenomenon, occurring only at the surfaces of the substrate. On structural modification of the cellulose, such as swelling, substitution, depolymerization, or de-crystallization, this inaccessibility becomes less of a limiting factor, resulting in rapid and efficient hydrolysis. Acids, on the other hand, because of their relatively small size, can penetrate readily into the structure of un-altered cellulose. The increased accessibility of the substrate to the acid catalyst thus correlates into an increased initial rate of hydrolysis over that observed with the enzyme catalyzed reaction (Gascoigne and Gascoigne 1960; Ward and Seib 1970).

While the effect of substrate structural features on the enzyme catalyzed hydrolysis is understood, the mode of action of the enzymes at the surface is much less clear. To begin with, the term "cellulase" actually refers to a group of enzymes that contribute to the overall degradation of cellulose to glucose. In cellulolytic organisms, several cellulase components form a cellulase complex that synergistically hydrolyzes the cellulosic substrate.

Reese et al. (1957) originally proposed that the hydrolysis of cellulose was catalyzed by two enzymes, C1 and Cx. According to this proposal, C1, activates or deaggregates the cellulose chain in preparation for attack by the next hydrolytic component of the cellulase complex. The second component Cx, hydrolyzes soluble derivatives of cellulose or swollen and partially degraded cellulose, while not attacking the highly ordered substrates.

Today, the mechanisms of enzymatic hydrolysis are better explained in terms of the sequential action of three different types of enzymes, rather than the two proposed by Reese. According to Wood and McCrae (1979) and Fan et al. (1987), crystalline cellulose is effectively rendered soluble by the cooperative action of endo-glucanase and exo-glucanase enzymes. The third enzyme, cellobiase, then catalyzes the hydrolysis of the B-glucosidic linkage of cellobiose, yielding D-

glucose. Table 6 shows the different enzymes of the cellulase complex along with the substrates and products of their actions.

Nitrocellulose

While cellulose can be degraded by fungi and bacteria, or more specifically, the enzymes produced by these microorganisms, the degradability of nitrocellulose by these microorganisms has been questioned. The apparent inability of enzymes to degrade nitrocellulose possibly stems from the structural features of the nitrocellulose. In particular, the degree of substitution may play a vital role in its amenability to biological treatment.

According to Fan et al. (1987), substituted cellulose derivatives are formed by replacing the hydrogen of the primary and secondary hydroxyl groups with reactive groups such as methyl, ethyl, hydroxyethyl, and carboxymethyl. The addition of these groups makes cellulose less crystalline and more soluble in water in proportion to the degree of substitution and the solvating capacity of the substituent groups. The degree of substitution at which the complete solubility is attained ranges from 0.5 to 0.7, depending on the solvating capacity of the substituents and the degree of polymerization of the cellulose.

The susceptibility of substituted cellulose derivatives to enzymatic hydrolysis increases as the derivatives become more water soluble and less crystalline up to the point of complete solubility. After this, the susceptibility decreases with the increasing degree of substitution until complete immunity to the enzymatic action results. This usually occurs at a degree of substitution slightly greater than 1.0. Highly nitrated cellulose, as used in industry and munitions, usually has a degree of substitution between 2.0 and 3.0, 3.0 being the theoretical maximum. In addition, as the degree of substitution increases to the theoretical maximum, the NC structure once again becomes highly crystalline, thus adding to its inaccessibility to enzymatic attack.

Urbanski (1964) investigated this apparent nonsusceptibility by studying the growth of mold, specifically *Aspergillus*, on wet NC. However, after extensive study, it was determined that the observed growth was due to contaminants

Table 6. Enzymes of the cellulase complex from Jeffries (1987).

Systematic name	Trivial names	Substrate/Product
1,4-B-D-glucan cellobiohydrolase	exoglucanase, cellobiohydrolase	crystalline cellulose/ cellobiose
endo-1,4-B-D-glucan 4-glucanohydrolase	endoglucanase, B-glucanase	amorphous cellulose/ cellooligosaccharides
B-D-glucoside glucohydrolase	cellobiase, B-glucosidase	cellobiose, triose/ glucose

found in or on the nitrocellulose such as hemicellulose, and not due to the degradation of the NC. While these studies confirmed NC's resistance to enzymatic attack, the author did find that organic acids produced by *Aspergillus* during the metabolism of the contaminating material, resulted in limited acid hydrolysis of the structure.

Gallo et al. (1993) reported on a study of the microbial degradation of NC using three different microorganisms: *Phanerochaete chrysosporium*, *Aspergillus fumigatus*, and an unidentified Actinomycete. Their results supported the conclusion that none of the microorganisms studied were able to use nitrocellulose as a carbon source. There was evidence, however, that some hydrolysis occurred when *Aspergillus fumigatus* and Actinomycete were cultured with NC.

While the results of direct biodegradation studies for the treatment of nitrocellulose are inconclusive, possibly leaning towards nondegradability, results of biodegradation studies on nitrocellulose following acid or base catalyzed pretreatment are positive.

Wendt and Kaplan (1976) conducted extensive studies on the biodegradation of NC following alkaline catalyzed pretreatment. In this study, the chemically pretreated NC, raw waste water, and an additional carbon source (glucose) were fed continuously into a bench-scale, denitrification-activated, sludge treatment system. Denitrification and activated sludge were both incorporated into the treatment scheme based on the high nitrate and organic content of the NC hydrolysate. The five steps integrated into Wendt and Kaplan's system were: (1) initial denitrification, (2) sedimentation, (3) agitated and aerated activated sludge, (4) secondary denitrification, and (5) final sedimentation. The first denitrification step reduced the initial nitrate concentration from approximately 165 to 5 mg/L. Microbial breakdown of the organic compounds then took place in the activated sludge phase of the treatment. During this phase, the nitrate content of the waste water was increased from 5 mg/L to approximately 90 mg/L through nitrification. Secondary denitrification, using glucose as a supplemental carbon source, then reduced the nitrate concentration to approximately 5 mg/L in the effluent.

A mass-balance on BOD₅, COD, and TOC indicated relatively efficient removal of BOD, but less satisfactory removal of TOC and COD. According to the authors, overall BOD removal was 88.6 percent, while the removal of TOC and COD was 54.5 and 55.2 percent, respectively.

These authors concluded that the biological treatment of chemically pretreated nitrocellulose was a suitable alternative that required a carbon-energy source and that the effluent apparently did not contain any toxic products formed during the chemical-biological treatment process.

3 Analytical Methods and Test Procedures

Analytical Methods

Throughout the hydrolysis studies, various routine and nonroutine chemical analyses were conducted on the hydrolysate samples. The aim of these analyses was to gain a better understanding of the mechanisms involved and the products generated by the hydrolysis process.

Routine Analytical Tests

pH. Following alkaline hydrolysis of the nitrocellulose, the pH of the resulting hydrolysate samples was adjusted, as necessary, to pH 7.0 - 8.0 using sulfuric acid. Neutralization of the samples was done to halt the hydrolysis process and to facilitate subsequent testing. All pH measurements were made using a Fisher all purpose electrode and Fisher accumet pH meter Mdl. 825 MP, calibrated at pH 7.0 and 10.0.

Nitrite, Nitrate, and Ammonia. Nitrite and nitrate analyses were conducted using a Dionex Mdl. 2000i/SP ion chromatograph with an AS4A 4mm Ion Pac column (2.8 mM NaHCO₃/2.3 mM Na₂CO₃ eluant, 100 and 300 μ S output range). Standards and solutions were prepared in accordance with Standard Methods for Water and Wastewater Examination, procedure 429 (1991). Prior to analysis, samples were filtered through 0.45 μ m filters and diluted 10:1 to 50:1 depending on the expected anion concentration.

Total ammonia was measured using an ammonia electrode (Orion Mdl. 95-12) and ion analyzer (Orion Mdl. EA 940). This instrument was calibrated daily prior to analysis. Because of the high pH of the digesting samples, loss of ammonia through volatilization was a possibility. To determine the magnitude of this loss, a limited number of off-gas ammonia measurements were conducted with off-gas scrubbers filled with a sulfuric acid solution to trap the NH₃. These samples were then analyzed using the ammonia electrode.

Soluble Carbon. Soluble carbon measurements were obtained with a Dohrmann Mdl. DC-80 total carbon analyzer. Standard solutions were prepared from a 2000 mg/L carbon stock solution of Potassium Hydrogen Phthalate (KHP). Standards ranged in concentration from 10 to 800 mg/L. To avoid any organic contamination, all dilutions were made using distilled water.

The carbon analyzer provided either organic or inorganic carbon results. Organic carbon was determined by the "sparge" technique. In this technique the carbon from carbonate and bicarbonates is removed by first acidifying the sample to a pH less than 2, and then bubbling a clean gas through the sample to remove carbon dioxide from solution. Interestingly, attempts to obtain a carbon mass-balance during these extremely high pH digestion runs were somewhat complicated by the "covert" sorption of carbon dioxide from the atmosphere. While this sorption of carbon dioxide caused interference in the determination of inorganic carbon, interference with organic carbon measurements was minimized by increasing the sparge time of the samples.

Suspended Solids. Total and volatile suspended solids analyses were conducted using Whatman 934-AH glass microfibre filters in accordance with Standard Methods (1991).

Chemical Oxygen Demand. Soluble chemical oxygen demand was determined using the Reactor Digestion-Spectrophotometric Method. This method uses dichromate as an oxidizing agent, as does the traditional method. However the digestion technique is modified to use semi-micro volumes of the sample and reagents in 10 ml borosilicate vials. COD reagent vials, covering COD ranges of 0-1,500 mg/L and 0-15,000 mg/L, were obtained from HACH Chemical Company.

The oxygen demand was determined by mixing the soluble portion of the hydrolysate sample with the COD reagent covering the appropriate COD range. The vials were then digested for 2 hours at 150 °C in a HACH COD Reactor. On cooling, vials were analyzed at 620 nm using a Bausch and Lomb SPEC 20 spectrophotometer. The absorbance reading was recorded, and subsequently plotted on a prepared standard curve to determine the COD values. COD standards were prepared in accordance with Standard Methods (1991).

Non-Routine Analytical Tests

Carbohydrate. The phenol/sulfuric test was used to determine the carbohydrate concentration in the hydrolysate (Dubois et al. 1956). Duplicate 2.0 ml samples of filtered (0.45 µm) hydrolysate were pipetted into screw cap Pyrex test tubes. A reagent blank was prepared using deionized water, and three dilutions of a

standard 100 mg/L glucose solution were also pipetted into Pyrex test tubes. One ml of 5 percent phenol in water, and 5 ml of concentrated sulfuric acid were then vigorously syringed into each test tube. The tubes were allowed to stand for 10 minutes, then they were shaken and placed for 10 to 20 minutes in a 30 °C heating block before measuring absorbance. The reaction leads to the development of a yellow-orange color complex in the presence of simple sugars, oligosaccharides, polysaccharides, and their derivatives (including the methyl ethers with free or potentially free reducing groups). The glucose dilutions were used to develop a standard curve. Each sample was then analyzed at 490 nm using a Bausch and Lomb SPEC 20 spectrophotometer.

Cyanide. Particular emphasis was placed on determining cyanide production during the hydrolysis of the NC. While prior research (Hirayama and Smith 1988) had shown cyanide concentrations ranging from ~0.03 to ~0.1 mg/L being formed during this process, there existed the possibility of much higher concentrations being formed. This was of great concern because elevated cyanide levels could greatly reduce the final utility of the process. Two methods were selected to analyze for cyanide. Preliminary cyanide screenings were conducted using an ORION selective ion electrode. This method, however, provided highly variable results. Because of this, HACH cyanide powder pillows were chosen for all subsequent cyanide testing. The HACH cyanide analysis uses the pyridine-pyrazolone method for measuring cyanide. The pyridine-pyrazolone indicator gives an intense blue color with free cyanide. Transition and heavy metal cyanide complexes are not measured using this method. The test procedure was carried out by first neutralizing the alkaline solution to pH 7 immediately prior to testing. Ten ml of the neutralized solution were then pipetted into screw-cap Pyrex test tubes. Because of the intense color of the digested solution, dilution was sometimes necessary to avoid interference with the color production. Cyanide standards ranging from 0.12 to 0.04 mg/L were prepared and also pipetted into test tubes. CyaniVer 3, 4, and 5 Cyanide Reagent Powder Pillows were then added to the test tubes following the manufacturer's recommended procedure (HACH Chemical Company 1980). The test tubes were allowed to react for 30 minutes. The samples and standards were then transferred to spectrophotometer cuvettes, and absorbance was read against the reagent blank at 612 nm.

Nitrocellulose Nitrogen. The nitrogen content of the nitrocellulose waste suspension received from RAAP was subjected to the classic Schultz-Tiemann test method to approximately identify its nitrogen content (Dorée 1950). This semi-quantitative test involves the careful measurement of nitric oxide gas (NO) released from the sample when treated with a strong acid (HCl) in the presence of a strong reducing agent (ferrous chloride), according to the following reaction:

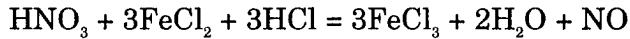

Under the direction of Dr. Diane Stott (National Soil Erosion Lab, Purdue, IN), a more precise nitrogen determination was then made using a total elemental analyzer. Figure 4 shows a schematic of the Schultz-Tiemann test apparatus.

Gas Chromatography/Mass Spectroscopy. Finally, analytical research dealing with structural aspects of the post-digestion organic carbon species was attempted using a Hewlett-Packard GC/MS system. All GC/MS analytical work was conducted under the direction of Karl Wood of the Chemistry Department, Purdue University. Samples subjected to these analyses were first extracted using methylene chloride and then concentrated approximately one hundred fold prior to analysis.

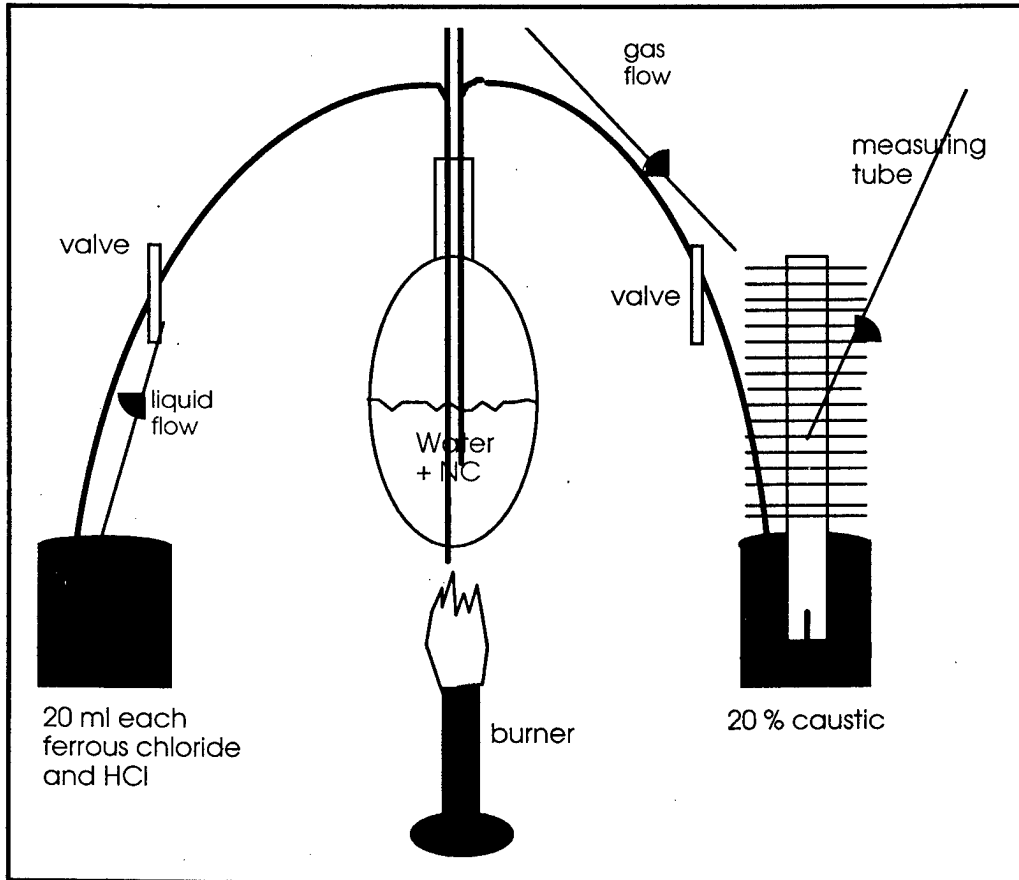

Figure 4. Schultz-Tiemann test apparatus.

Test Procedures

Preliminary Alkaline Hydrolysis and Biodegradation Studies

Alkaline Hydrolysis Studies. Preliminary alkaline hydrolysis experiments were conducted using the "industrial-grade" nitrocellulose. During these initial studies, emphasis was given to evaluating various alkalis (sodium hydroxide, potassium hydroxide, and calcium hydroxide), reaction temperatures (25, 35, and 50 °C), digestion times (ranging from 1 to 24 hours), caustic concentrations (ranging from 1 to 10 percent by weight), and NC concentrations (from 1 to 7 percent by weight).

These tests were performed to verify the feasibility of the alkaline hydrolysis process and to estimate testing parameters. Quantification of the test results was based on the determination of the combined nitrite and nitrate nitrogen found in the hydrolysate following digestion as a percent of the total original nitrogen contained in the NC. These experiments were run using a gang of magnetically stirred 125 ml nalgene bottles bearing the various alkali and NC mixtures. Prior to testing, the NC samples were dried at room temperature for 1 week to ensure constant weight.

As an example, the first trial was performed by weighing out 1.0 g of dry NC and 1.0 g of sodium hydroxide pellets into the nalgene bottle. The volume of the reactor was then brought to 100 ml with D.I. water to give final caustic and solids concentrations of 1.0 percent weight to volume. The samples were then digested at 25 °C for the determined amount of time. This procedure was repeated for each of the various combinations of solids, caustic dose, and temperature. For elevated temperature runs, these reactors were fitted with a surrounding heat-transfer jacket supplied with water from a controlled temperature circulating water bath (maintaining temperatures within $\pm 1^\circ\text{C}$ between four reactors). As necessary during any given batch run, samples were withdrawn from the reactors and neutralized with sulfuric acid to a pH of ~ 7.0 to 8.0, in preparation for subsequent analytical testing (nitrite and nitrate release). Sulfuric acid was used for neutralization so as to replicate the real world process where it is anticipated that recovered sulfuric acid/water would be used for neutralization. Figure 5 shows the reactor assembly used for all alkaline hydrolysis studies. Table 7 shows the various parameters and ranges evaluated during the preliminary studies.

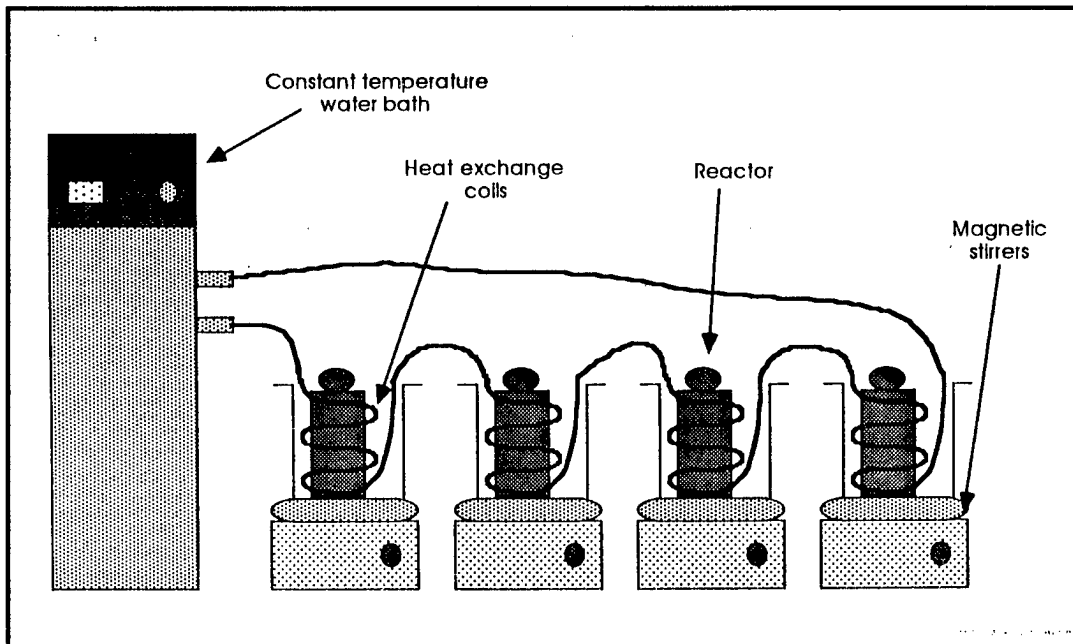

Figure 5. Reactor assembly used in alkaline hydrolysis studies.

Table 7. Preliminary hydrolysis testing parameters.

Caustic Type	Digestion Time	Digestion Temp.	Caustic Concentration	Nitrocellulose Concentration
NaOH	1 - 24 hr	25° C	1, 5, 10% (w/v)	1, 3, 5, 7% (w/v)
NaOH	1 - 24 hr	35° C	1, 5, 10% (w/v)	1, 3, 5, 7% (w/v)
NaOH	1 - 24 hr	50° C	1, 5, 10% (w/v)	1, 3, 5, 7% (w/v)
KOH	1 - 24 hr	25° C	1, 5, 10% (w/v)	1, 3, 5, 7% (w/v)
KOH	1 - 24 hr	35° C	1, 5, 10% (w/v)	1, 3, 5, 7% (w/v)
KOH	1 - 24 hr	50° C	1, 5, 10% (w/v)	1, 3, 5, 7% (w/v)
Ca(OH) ₂	1 - 24 hr	25° C	1, 5, 10% (w/v)	1, 3, 5, 7% (w/v)
Ca(OH) ₂	1 - 24 hr	35° C	1, 5, 10% (w/v)	1, 3, 5, 7% (w/v)
Ca(OH) ₂	1 - 24 hr	50° C	1, 5, 10% (w/v)	1, 3, 5, 7% (w/v)

Biodegradation Studies. Preliminary BOD tests were conducted using the industrial-grade NC to determine what effect the hydrolysis phase of the treatment had on the amenability of the NC to biodegradation. These tests were run at 25 °C on samples that had previously been subjected to alkaline hydrolysis for 6 hours at 1 and 4 percent (w/v) NaOH. Tests were run over periods of 5 to 7 days.

An attempt was made to promote acclimation of the seed used in these tests through extended prior exposure of a full-scale municipal-industrial activated sludge culture to the post-digestion liquors. In addition, the seed culture was spiked immediately before use with a known nitrifying bacteria, including both ammonia and nitrite oxidizers. Two types of samples were subjected to this BOD testing method, including complete post-digestion liquors (i.e., neutralized but unfiltered), and solids remaining after alkaline digestion (i.e., which had been filtered from the liquor).

In the BOD tests conducted using the liquid samples, 2.0 ml of acclimated seed bacteria and 15 ml of neutralized hydrolysate were added to a 400 ml graduated reactor bottle. The reactor contents were then brought up to 300 ml total volume using BOD dilution water prepared in accordance with Standard Methods (1991). For those BOD tests using solids only, 2.0 ml of acclimated seed bacteria and 0.5 g of rinsed and dried residual solid NC were added to the graduated reactor bottle. Again the contents were brought up to 300 ml total volume using the standard BOD dilution water. BODs were then calculated using a four-cell N-CON Respirometer MDL WB-400 COMPUT-OX.

Hydrolysis Optimization and Kinetic Studies

Plackett-Burman Statistical Screening. Once preliminary experimentation had verified the feasibility of the alkaline treatment process, the next step was to determine the hydrolysis kinetics and to try to optimize the overall process. Since the primary research objective was to reduce the quantity of NC fines accumulated in the manufacturing wastewater, suspended solids solubilization was selected as the primary measure for successful treatment. This was done in the belief that once solubilized, the resulting hydrolysate would be substantially amenable to biodegradation.

Hydrolysis tests carried out during this phase of the investigation were conducted in 250 ml nalgene bottles. Temperature and mixing were controlled as previously described. Total solids analysis was performed using Whatman 934-AH glass microfiber filters in accordance with Standard Methods (1991).

To determine which hydrolysis conditions had a significant impact on the solubilization of the NC, and thus should be included in the determination of the hydrolysis kinetics, a statistical analysis of the effects of various parameters (reaction time, reaction temperature, alkali concentration, and initial NC solids concentration) was conducted. The Plackett-Burman statistical screening analysis (Mason et al. 1989) was selected as a first step to determine which, if any, of these four parameters had a statistically significant impact.

The Plackett-Burman experimental design provides an efficient means of exploring the effect of multiple factors without running a multitude of experiments. It enables the user to separate the important parameters from the unimportant ones. It also provides a straightforward approach to statistical analysis of the data, where the main effects of all factors are estimable and separable.

Table 10. Parameter setting during each trial.

Trial No.	Time	Temp	NaOH	NC
1	+	+	-	+
2	+	-	+	+
3	-	+	+	+
4	+	+	+	-
5	+	+	-	-
6	+	-	-	-
7	-	-	-	+
8	-	-	+	-
9	-	+	-	+
10	+	-	+	+
11	-	+	+	-
12	-	-	-	-

Kinetic Studies. Based on the results of the screening tests, it was determined that time, temperature, and caustic dose all had a significant effect on the solubilization of the nitrocellulose. It was also determined that the initial nitrocellulose concentration did not have a statistically significant effect on the solubilization reaction.

The next step in the optimization process was the development of an empirical model that would describe the solubilization, as well as the denitration of the nitrocellulose. This involved establishing both the mathematical form of the empirical rate law for the hydrolysis of the nitrocellulose ester, and the determination of the rate constants as a function of temperature and other relevant conditions. Thus, various temperatures, times, and caustic dosages were analyzed in tests conducted to determine rate constants, while the total initial solids were held constant. The same testing protocol was used to determine both the denitration and solubilization rate constants for the NC. By plotting the results of these studies, a series of temperature dependent rate constants, as well as the Arrhenius factors A (frequency factor) and E_a (activation energy) were determined. Table 11 shows the testing protocol used for the determination of these rate constants.

Molecular Weight Distribution Studies

Molecular weight distribution studies were conducted to help determine the mechanisms involved in the hydrolysis process, as well as to show trends toward biodegradability. Several investigators (Eastman and Ferguson 1981; Pavlostathis and Gossett 1986; Han and Callihan 1974) have noted that the biodegradation rate of organics in domestic wastewater, as measured by a BOD test, increases with decreasing molecular size. Thus, determination of the size

Table 11. Testing protocol for rate constant determination.

Time (hrs)	Temp. (°C)	NaOH (mg/L)	Initial NC (mg/L)
2 - 24	35	20,000	10,000
2 - 24	45	20,000	10,000
1 - 24	55	20,000	10,000
1 - 24	65	20,000	10,000
2 - 24	35	20,000	10,000
2 - 24	35	40,000	10,000
1 - 24	35	60,000	10,000
1 - 24	35	80,000	10,000
1 - 24	35	100,000	10,000
1 - 24	35	120,000	10,000

distribution of the hydrolysate would tend to shed light on the inherent biodegradability of these organics.

Size distributions of dissolved organics are determined either as a continuous distribution using gel permeation or size exclusion chromatography, or as a discrete distribution using ultrafiltration membranes in stirred cells. The ultrafiltration method was selected for these studies. Discrete distributions using these membranes are obtained by either serial or parallel processing of the samples through an array of pressurized stirred cells containing the various membranes. Of these methods, parallel processing of samples in batch mode is preferred since multiple handling of the filtrates is not required, and large sample volumes can be processed and recovered for further characterization (Logan and Jiang 1990).

All size distribution studies on the hydrolyzed NC were conducted at room temperature in a 50 ml stirred cell (Model 8050, Amicon Corp., Danvers, MA) pressurized to 55 psi using nitrogen gas. The type and nominal molecular weight cutoffs of the membranes, as specified by the manufacturer were: YC05 = 500 amu, YM1 = 1,000 amu, YM3 = 3,000 amu, YM10 = 10,000 amu, YM30 = 30,000 amu, XM 50 = 50,000 amu, YM100 = 100,000 amu, XM300 = 300,000 amu. After each batch analysis, the ultrafiltration membranes were washed and stored in 5 percent ethanol solution. Each membrane was discarded after 10 batch cycles. All samples were prefiltered through 0.45 μm (approximately 500,000 amu) filters to remove bacteria and colloidal matter. Quantification of the fraction removed by each membrane was obtained by total organic carbon (TOC) analysis of a given sample before and after ultrafiltration. TOC was measured with a Dohrmann DC-80 total carbon analyzer. Figure 6 shows the processing scheme used to determine size distributions of the hydrolyzed nitrocellulose. Figure 7 shows a schematic of an isolated ultrafiltration cell.

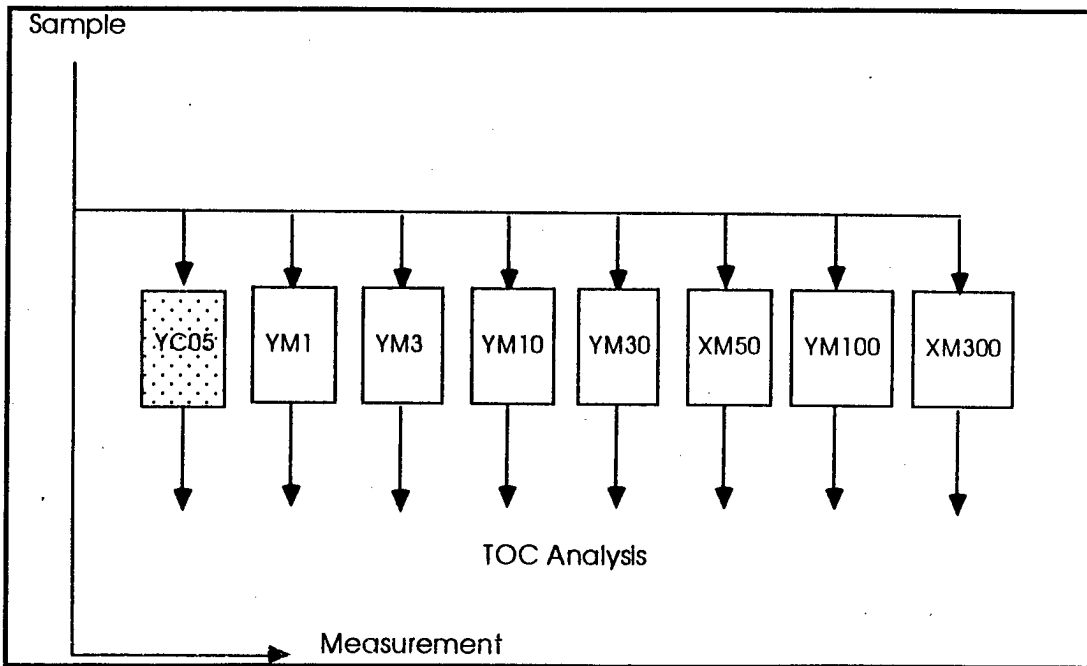

Figure 6. Molecular weight distribution protocol schematic.

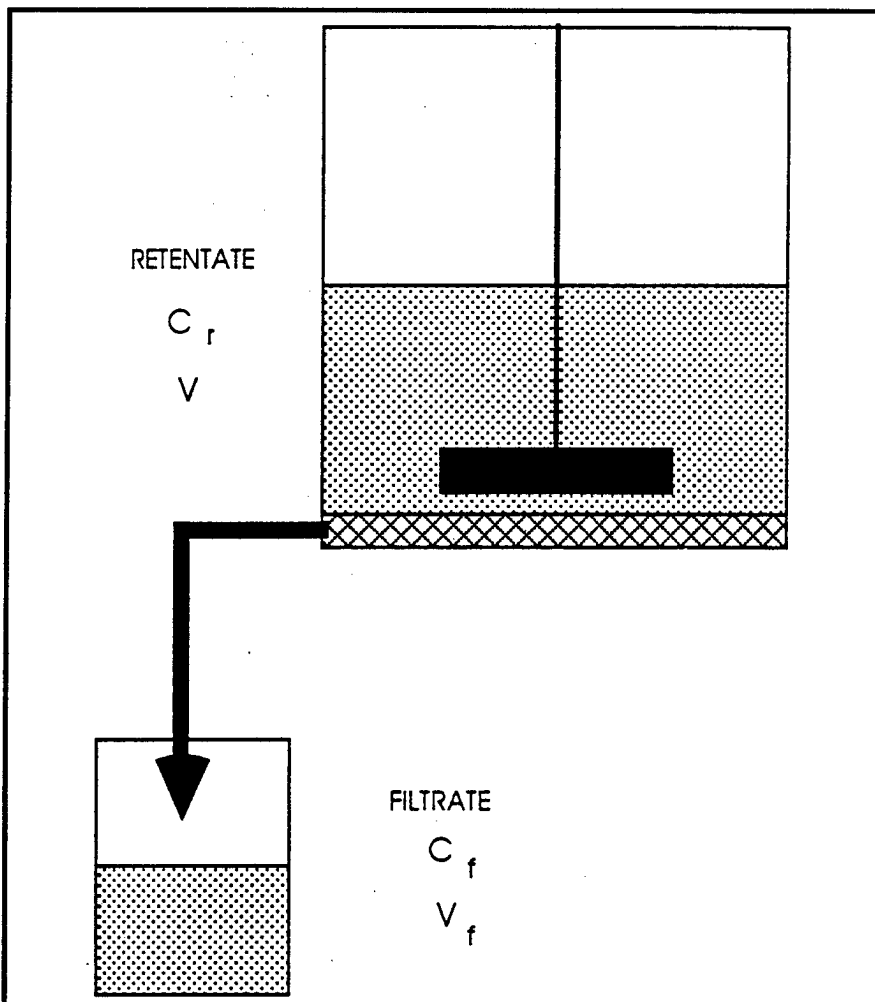

Figure 7. Individual ultrafiltration cell.

Microtox Toxicity Tests

Toxicity screening tests were performed on the hydrolysate before biological treatment. These tests were conducted to determine if the hydrolysate would have an adverse effect on an activated sludge wastewater treatment facility in the concentrations most likely to be encountered in an actual full scale treatment process.

The Microtox Test was chosen for these toxicity screening tests. The Microtox Test exposes organisms to test samples, and measures the toxic effect of the sample on the organisms. The Microtox Reagent contains living bioluminescent bacteria. The test measures the light output of the luminescent bacteria after they have been challenged by a sample of unknown toxicity, and compares it to the light output of a control (reagent blank) that contains no sample. The difference in light output is attributed to the effect of the sample on the organisms. The degree of light loss (an indication of metabolic inhibition in the test organisms) indicates the degree of toxicity of the sample.

Microtox is usually employed for the determination of a dose-response curve, on which the effective concentration (ECXX) that causes a particular percent of light loss can be obtained. Because some compounds affect the test organisms immediately, while others take several minutes to complete their effect, light output at 1, 2, or 3 different time intervals can be measured. This would thus result in the determination of up to 3 ECXX values per test (Microbics Corporation 1992).

For all hydrolysate toxicity tests an effective concentration of 50 percent was chosen. This value represented the hydrolysate concentration resulting in a 50 percent decrease in the light output of the bacteria compared to the light output of the control organisms. In addition, EC50 values were determined for time intervals of 10 and 20 minutes for each hydrolysate sample.

Two different test protocols were followed for the hydrolysate toxicity tests. The first was a condensed protocol Basic Test used for samples with very high levels of toxicity. For samples with a lower expected toxicity level a condensed protocol for a 100 Percent test was used. While the 100 Percent test was easier to perform, it does not contain a correction for pipetting errors thus decreasing the precision of the test. Figures 8 and 9 show the condensed protocols for the Basic Test and the 100 Percent Test, respectively.

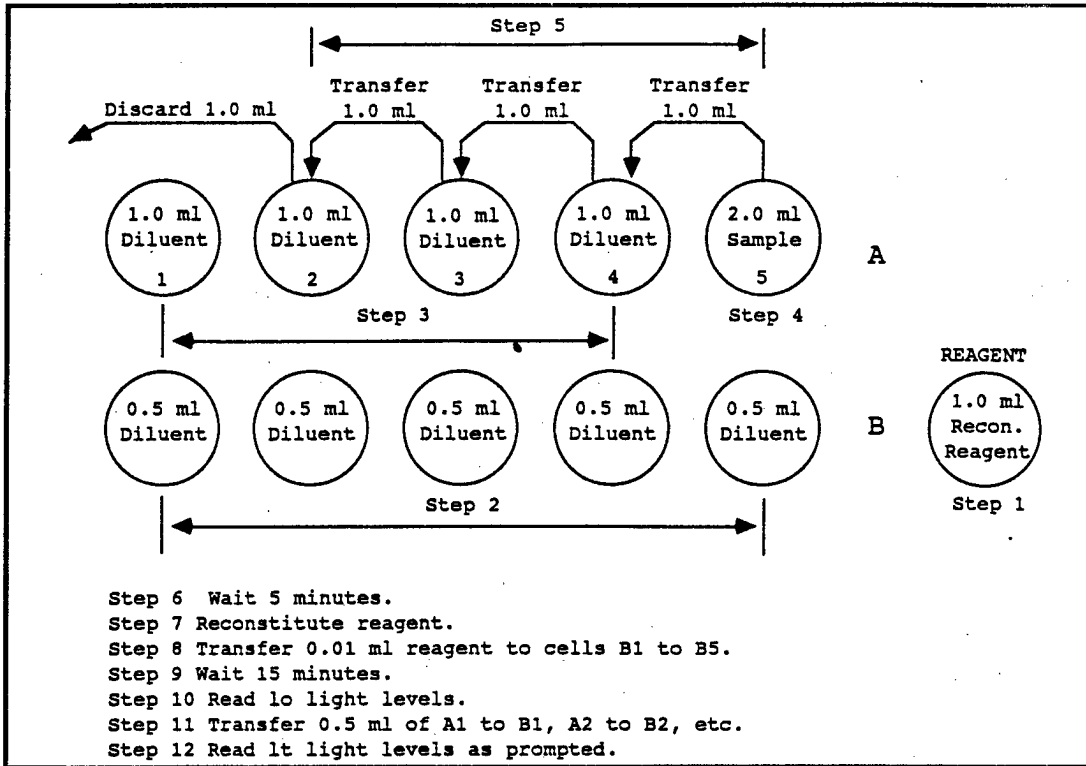

Figure 8. Condensed protocol for Microtox Basic Test (Microbiotics Corp., 1992).

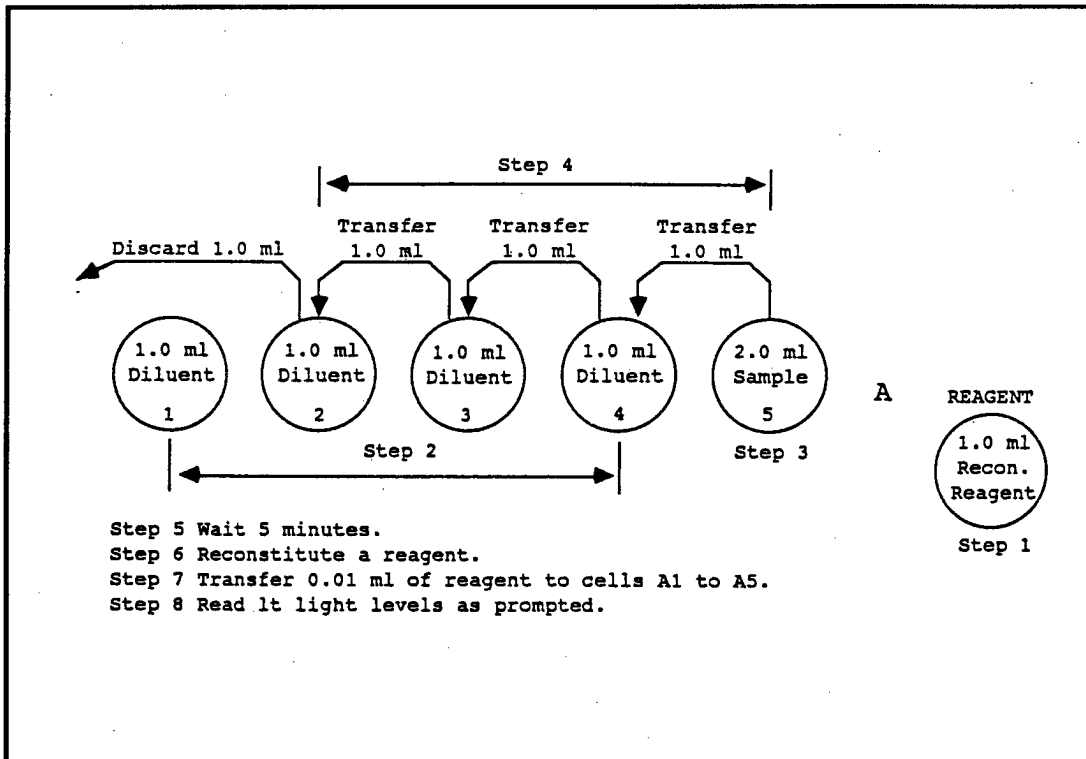

Figure 9. Condensed protocol for Microtox 100% Test (Microbiotics Corp., 1992).

Hydrolysate samples were prepared by digesting 1 percent (w/v) NC in 2, 6, and 10 percent (w/v) NaOH at temperatures of 30, 50, and 70 °C. Temperature and mixing were controlled, and the samples were prepared as described in previous sections. Sampling times were varied slightly from previous tests. For the 30 °C caustic digestions, hydrolysate samples were taken at 6 and 24 hours. Hydrolysate samples from the 50 °C digestions were taken at 4 and 12 hours. Because the rate of digestion is so fast at 70 °C, only one sample time (4 hours) was used for each of the 3 caustic concentrations. Statistical analysis of the data was performed by the Microtox software.

Post-Hydrolysis Biodegradation Studies

Detailed biodegradation studies were conducted following hydrolysis of the munitions-grade nitrocellulose to determine at what point in the alkaline hydrolysis process the hydrolysate becomes substantially amenable to biodegradation.

The seed bacterial culture used in the biodegradation studies was started from a municipal activated sludge and maintained for approximately 8 months in a cone shaped, 5-L reactor. Filtered laboratory air was used for both mixing and aeration. Wasting and feeding were done at the rate of 200 ml per day. Since solids wasting was performed on the mixed liquor in a completely mixed state, the hydraulic residence time and the mean cell residence time were both 25 days.

The bacterial culture was fed a combination of digested NC (20 g/L), D-glucose (12 g/L), and Tryptic Soy Broth (12 g/L). The feed solution was then diluted 4 times resulting in a final concentration of NC (5 g/L), glucose (3 g/L) and TSB (3 g/L). This dilution was done in part to counteract any possible inhibitory effects caused by the high ionic strength resulting from the hydrolysis/neutralization of the NC. The NC used in the feed solution was subjected to hydrolysis in 6 percent caustic at 45 °C for 24 hours. While the optimum hydrolysis conditions had not yet been determined, it was likely, based on preliminary results, that hydrolysate prepared in this manner would provide a biologically usable substrate. In addition to the substrate just described, micronutrients, as used in the standard BOD test, were also added to the feed solution.

Prior to the biodegradation studies, the NC was subjected to alkaline hydrolysis in batches according to the following protocol: 1 percent (w/v) munitions-grade NC was digested using a gang of magnetically stirred reactors bearing the various alkali mixtures. These reactors were fitted with a surrounding heat-transfer jacket supplied with water from a controlled temperature circulating

water bath. Batches were hydrolyzed at temperatures of 30, 50, and 70 °C, and at caustic doses of 2, 6, and 10 percent (w/v). Samples (25 ml) were withdrawn at various intervals, neutralized, filtered, and subsequently tested for biodegradability using two, 4 four-cell N-CON Respirometers MDL WB400 COMPUT-OX connected in series. Each BOD bottle contained 25 ml of digested NC, 15 ml of the acclimated seed (~2,500 mg/L VSS) and 265 ml of dilution water. The BOD dilution water was prepared in accordance with Standard Methods (1991).

All biodegradation tests were conducted over 5 days at ~25 °C, during which time the respirometer tracked oxygen consumption quantified according to the cumulative oxygen uptake required to maintain a constant headspace partial pressure in the reactors. Both the total oxygen demand (mg/L) and the oxygen uptake rate (mg/L-hr) were measured and recorded hourly on the computer hard drive. Figure 10 shows the two N-CON Respirometers used for all biodegradation tests. In addition to BOD₅, COD and initial and final TOC values were also measured during these tests. COD values were obtained using HACH COD test vials covering COD ranges of 0-1,500 mg/L and 0-15,000 mg/L. TOC values were obtained using a Dohrmann DC-80 total carbon analyzer.

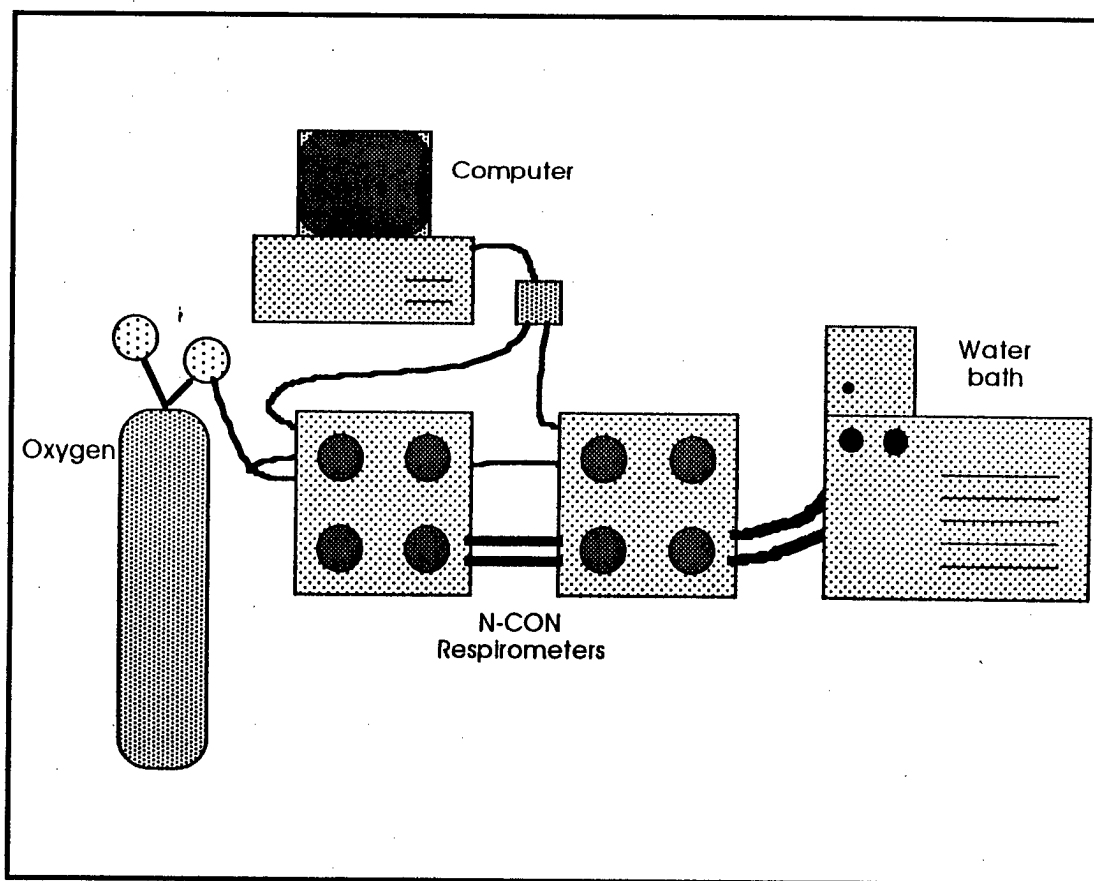

Figure 10. N-CON BOD reactor assembly.

Control experiments for the biodegradation tests were conducted using glucose as a substrate. These tests were conducted using 500 mg samples of glucose dissolved in 325 ml of seeded BOD dilution water, resulting in a glucose concentration of 1538 mg/L. This glucose solution had a theoretical oxygen demand of 1631 mg/L, a COD of 1551 mg/L and a BOD₅ of 996 mg/L. Because glucose is readily biodegradable, it was assumed that the ultimate BOD was nearly that of the COD. Typically in the 5-day BOD test, 60 to 70 percent of the carbonaceous organic matter is oxidized. If it is assumed that all of the carbonaceous organic matter is oxidized in the COD test, then the 996 mg/L BOD₅ value represents oxidation of 64 percent of the available organic matter.

Nitrification/Denitrification/Treatability Studies

The purpose of the nitrification/denitrification/treatability pilot studies was to investigate the impact of the NC hydrolysate on an existing wastewater treatment facility incorporating nitrification/denitrification. Specifically, these studies had three main goals: to allow an estimation of the yield created by the COD load in the hydrolysate stream (gram VSS produced/gram COD), to determine what fraction of the hydrolysate COD is biochemically degradable, and to assess the effect of the hydrolysate on nitrification/denitrification.

The initial activated sludge pilot scale setup consisted of a fill-and-draw reactor containing 3 L of mixed liquor. Aeration was supplied by an aquarium aeration pump. A diffusion stone was used to enhance oxygen transfer. Solids wasting was performed on the mixed liquor in a completely mixed state at a rate of 200 ml per day resulting in a hydraulic residence time (HRT) and mean cell residence time (SRT) of 15 days. To incorporate nitrification/denitrification the reactor was operated under both aerobic and anoxic conditions. Based on a review of the literature, it was determined that a 6-hour anoxic phase with periodic gentle mixing would be adequate for denitrification (Pesari and Grasso 1993).

The reactor was seeded with the same acclimated mixed bacterial culture as used in the biodegradation tests described in the previous section. The substrate for the reactor consisted of digested nitrocellulose only. While the "optimum" hydrolysis conditions had not yet been determined, the feed hydrolysate was prepared under conditions believed to result in a usable substrate. Specifically, this feed solution was prepared by digesting 25 g of NC in 500 ml of 6 percent (w/v) NaOH for 24 hours at 45 °C. This hydrolysate was then diluted to 2 L, resulting in a final concentration of 6.25 g/L NC, and an approximate TDS concentration of 6700 mg/L.

The pilot reactor was maintained for approximately 17 days. During this time influent and effluent COD, TOC, NO₂, NO₃, TSS, VSS, and OUR were monitored for one continuous 7-day period. Samples were collected immediately before wasting and feeding. Figure 11 shows the reactor setup used in the initial nitrification/denitrification/treatability study.

A second treatability study was later undertaken. In this study a continuous flow, 5-L rectangular reactor with a clarifier was used. Figure 12 shows the CFSTR reactor setup used in the second treatability study. This reactor was maintained at an SRT of 10 days and an HRT of 5 days. Aeration and mixing were provided via filtered laboratory air. Because the aeration basin was continuously aerated during this study, denitrification of the waste was not incorporated. However, because of the long HRT employed, limited denitrification was observed in the clarifier. The reactor was seeded with the same acclimated mixed bacterial culture as used in the initial treatability study.

The feed solution was prepared by digesting the munitions-grade NC, under what was determined to be near optimum conditions of 60 °C in 21,000 mg/L NaOH for 12.5 hours. This solution was then diluted to give a final NC concentration of 2 g/L. The reactor was operated for approximately 25 days and continuously monitored for 24 days (~2.5 SRTs), during which time influent and effluent COD, TOC, NO₂, NO₃, TSS, and VSS were measured.

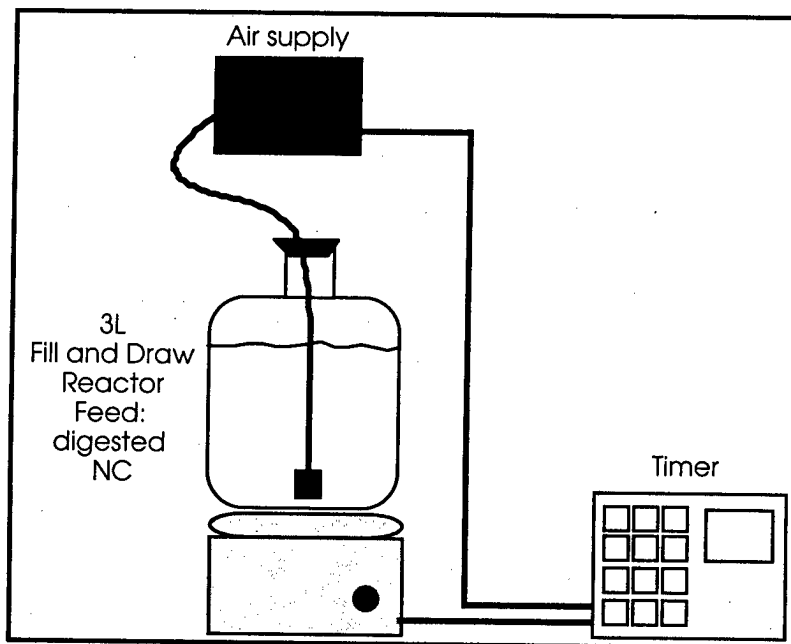

Figure 11. Nitrification/denitrification/treatability reactor configuration.

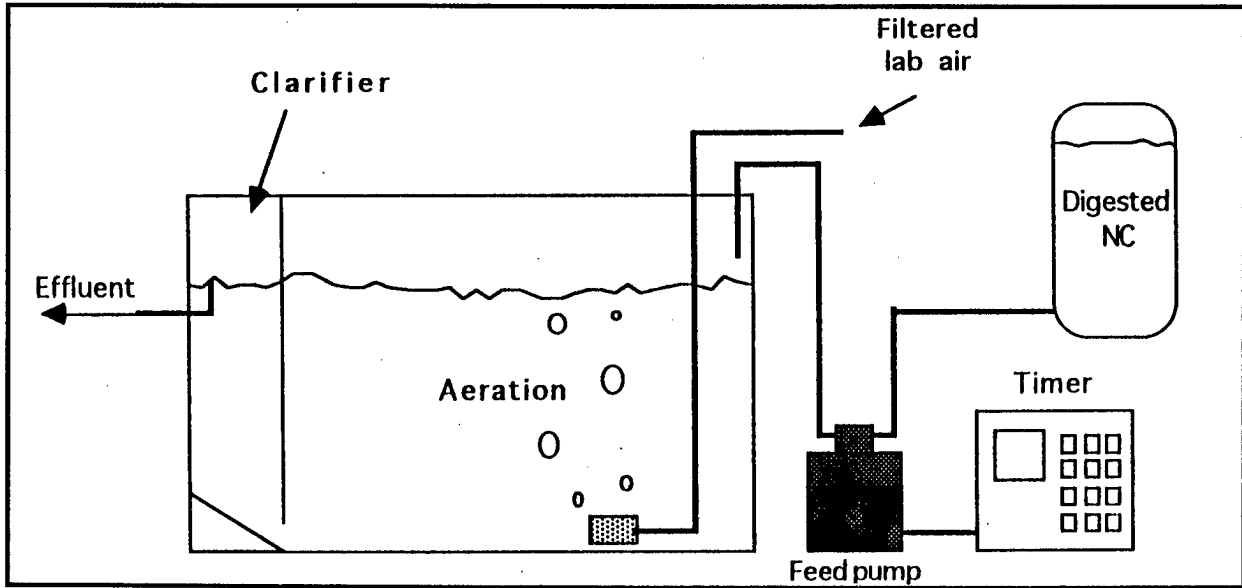

Figure 12. Treatability study continuous flow stirred tank reactor configuration.

4 Results and Discussion

Nitrocellulose Selection and Analysis

Hydrolysis tests were successively conducted using two different types of NC. The first was a virgin, industrial-grade substance provided by Aqualon, a subsidiary of Hercules, Inc. The second nitrocellulose samples represented real-world munitions-grade waste residue taken from RAAP.

The nitrogen content of the two samples was determined via the Schultz-Tiemann method and a total elemental analyzer. Nitrogen determinations on the munitions-grade nitrocellulose, using the Schultz-Tiemann method, ranged from 12.80 to 13.99 percent nitrogen by weight with an average of 13.24 percent. Using various sodium nitrate standards the efficiency of the procedure was determined to be 98 percent on 3 trials. Applying this efficiency to the 13.24 percent nitrogen measured in the trials resulted in a calculated nitrogen content of ~13.50 percent by weight. This nitrogen percentage was in the range expected for a high quality munitions-grade NC.

A more precise nitrogen determination was then made using a total elemental analyzer. Under the direction of Dr. Diane Stott (National Soil Erosion Lab, Purdue, IN), the samples were prepared and analyzed. Once the nitrogen content of the NC was known, the molecular weight of the NC was determined using the following formula (Miles 1955):

$$MW = \frac{5046}{31.13 - \% N}$$

Table 12 shows the results of the elemental analysis of the two nitrocellulose samples.

The carbon content of the two NC samples was determined via the elemental analyzer and the total carbon analyzer. The elemental analyzer results showed that the munitions-grade and industrial-grade NC contained 23.77 and 24.57

Table 12. Nitrocellulose elemental analyzer results.

Nitrocellulose	Carbon - %	Nitrogen - %	Ave. MW - g/mole
Munitions-Grade	23.77	13.15	280.65
Industrial-Grade	24.57	12.05	264.47

percent carbon, respectively. The theoretical carbon concentrations for these same two NC samples, based on the average molecular weights determined via Mile's formula, were 25.65 and 27.22 percent carbon, respectively. The mean carbon content and associated 95 percent confidence interval for the two nitrocellulose grades, determined via the total carbon analyzer, were 24.0 ± 1.0 percent and 28.0 ± 0.8 percent for the munitions-grade and industrial-grade NC samples, respectively.

Preliminary Alkaline Hydrolysis and Biodegradation Studies

Alkaline Hydrolysis Studies

The results of the preliminary alkaline hydrolysis studies conducted on the industrial-grade nitrocellulose are presented in Figures 13 through 16. These studies were designed to evaluate the effect of four parameters (caustic type, caustic dose, temperature, and initial solids) on the hydrolysis of the NC, as quantified by the change in the combined nitrite and nitrate nitrogen concentrations in the hydrolysate.

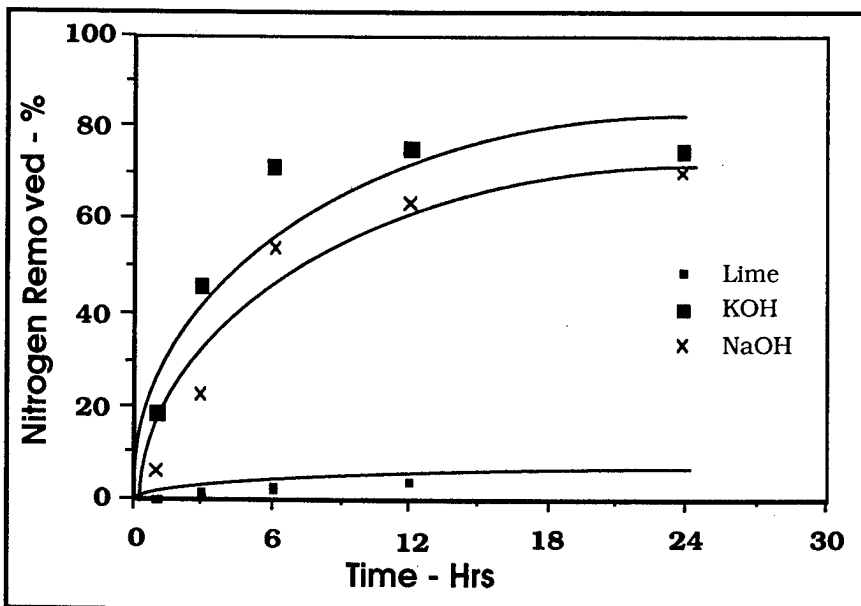

Figure 13. Nitrogen yield relative to caustic species.

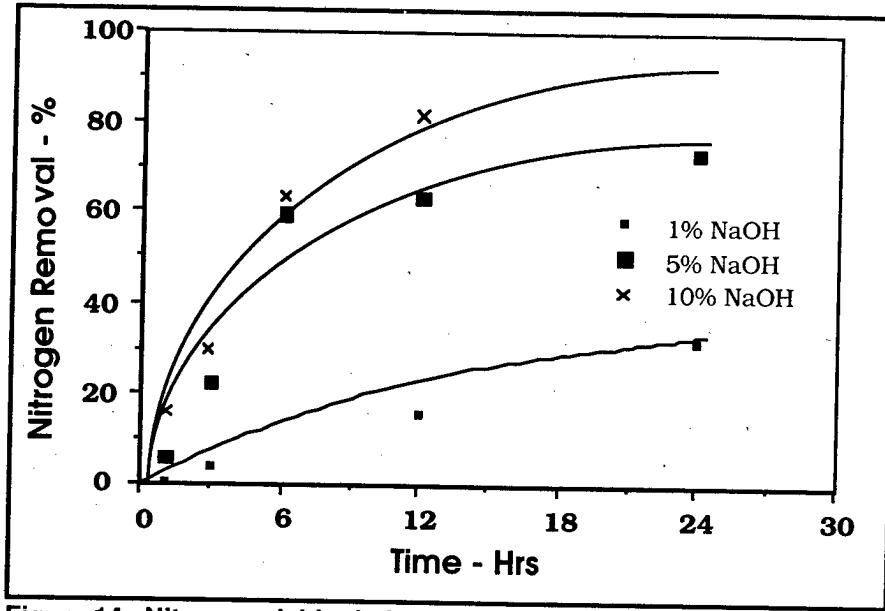

Figure 14. Nitrogen yield relative to caustic concentration.

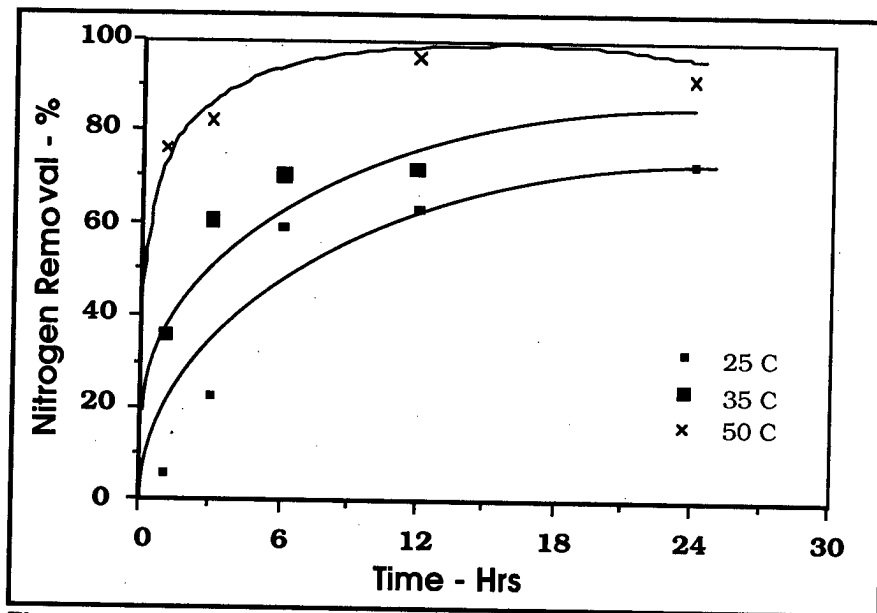

Figure 15. Nitrogen yield relative to hydrolysis temperature.

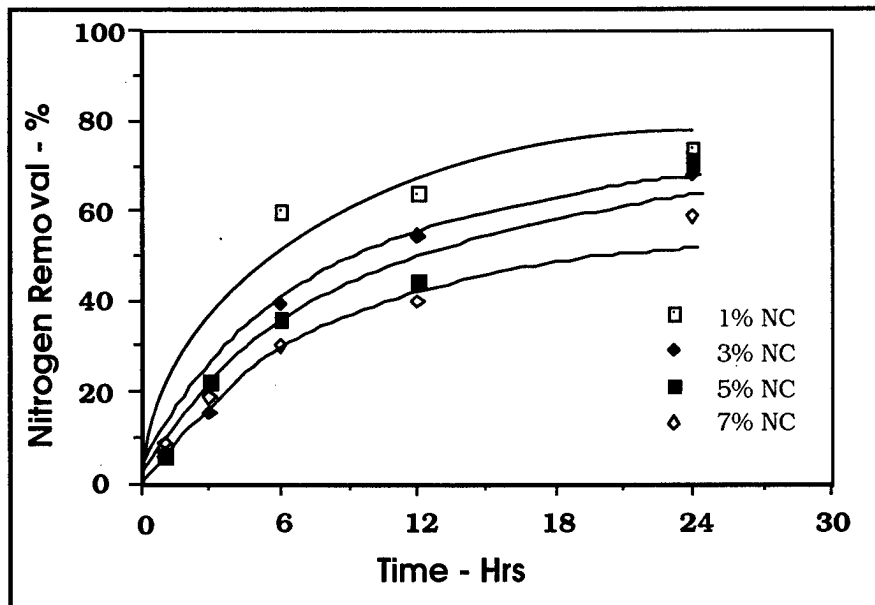

Figure 16. Nitrogen yield relative to NC concentration.

The most immediate visual change observed during the alkaline hydrolysis process was that of a distinct color change in the hydrolysate, from an initial cream color to progressively darker browns. This observed color change is not unlike that associated with the caramelization of sugar. A similar color change is also observed in the paper industry during the chemical pulping of cellulose fibers, thus giving "black liquor" its name. Commensurate to this color change, was a steady decrease in the concentration of particulate nitrocellulose, and a steady increase in the concentration of anionic nitrogen species in the hydrolysate.

Following hydrolysis, the samples were neutralized with concentrated sulfuric acid before analysis for nitrite and nitrate. It is important to note, however, that the quantity and distribution of nitrite and nitrate observed in the hydrolysate following neutralization appeared to depend on the way the samples were neutralized. Because of this loss and/or change in distribution of nitrogen species, the preliminary studies were more beneficial in showing hydrolysis trends than quantitative values.

Figure 13 shows the results of the hydrolysis as a function of the type of caustic used in the process. The three caustics (NaOH, KOH, and Ca(OH)₂) were all evaluated at a 5 percent concentration and a 25 °C reaction temperature. Of the three alkalis tested, NaOH and KOH proved to be quite effective in releasing the bound nitrogen from the NC at comparable dosage levels. Lime, on the other hand, was substantially ineffective in releasing the bound nitrogen.

Quantitatively, this conversion to nitrite and nitrate nitrogen reached approximately 880 mg/L as nitrogen for both NaOH and KOH. This value represents approximately 75 percent of the original nitrogen available for conversion. Therefore, based on the similar denitration results observed for NaOH and KOH and the greater cost associated with KOH, sodium hydroxide was chosen for all subsequent hydrolysis studies.

The next tests were conducted using sodium hydroxide, at constant temperature, to quantify the impact of the caustic concentration on the hydrolysis process. Whereas previous investigations (Kenyon and Gray 1936) had used caustic dosages up to 20 percent, lower values were employed during this study based on the desire to improve real-world utility and overall cost effectiveness (Figure 14). During these tests, the observed nitrogen removal, or conversion, increased relative to the higher caustic concentrations employed in the hydrolysis. This conversion ranged from approximately 31 percent of the available nitrogen at the 1 percent caustic concentration to approximately 80 percent at the 10 percent caustic concentration. From Figure 14, it also appears that, under the stated reaction conditions, very little was gained between hydrolysis at a 5 percent caustic concentration and the 10 percent concentration. These results are encouraging in that it appears the optimum caustic concentration for hydrolysis should be closer to 5 percent than 10 percent. This would result in significant cost savings as well as fewer problems in the subsequent neutralization and biodegradation stages of the process.

Next, the rate of hydrolysis as a function of the reaction temperature was investigated. The temperature-dependent hydrolysis results are presented in Figure 15. During these tests, hydrolysis at temperatures of 25, 35, and 50 °C was evaluated while the NaOH and NC concentrations were held constant.

As would be expected, based on kinetic theory, the initial rate of hydrolysis increased steadily and significantly with increasing temperature. This rate then decreased as the concentration of nitrogen remaining on the NC decreased. These results were also very encouraging in that it appears lower temperature hydrolysis in the range of 25 to 50 °C can result in substantial hydrolysis in a relatively short time (i.e., 10 to 75 percent nitrogen removal after 1 hour, or 60 to 90 percent nitrogen removal after 6 hours of digestion). Previous studies by Wendt and Kaplan (1976) had focused on much higher temperatures (i.e., 95 °C) for the hydrolysis. While these higher temperatures would result in faster hydrolysis, the problems associated with raising the digestion temperature to near boiling would probably offset any potential gains.

Finally, the effect of the initial NC concentration on subsequent hydrolysis is presented in Figure 16. These studies were conducted using a 5 percent sodium hydroxide solution at 25 °C. The initial NC concentration ranged from 1 to 7 percent or 10,000 to 70,000 mg/L.

It was observed during these studies that, as the initial NC concentration increased, the rate of hydrolysis decreased. Within the range of solids concentrations most likely to be encountered in a full scale hydrolysis treatment process (10,000 to 20,000 mg/L), this decreased rate would not be significant, representing only a 5 percent decrease in denitration, from approximately 75 percent to 70 percent after 24 hours of hydrolysis. This finding is in close agreement with that of Kenyon and Gray (1936), who found that the hydrolysis was, for the most part, independent of the initial NC to alkali ratio.

Biodegradation Studies

Preliminary biodegradation studies were conducted on both the hydrolysate and the residual solid NC following low level alkaline hydrolysis (i.e., 6 hours of digestion using 1 and 4 percent caustic concentrations at 25 °C). These studies were conducted to determine the amenability of the solubilized organics to subsequent biodegradation, and to determine if the hydrolysis process significantly altered the remaining particulate NC.

The results of the residual solids biodegradation studies are presented in Figure 17. While this figure depicts an oxygen demand for these samples, the magnitude of this oxygen demand is small compared with the oxygen demand which would exist if all of residual NC-C was biologically oxidized. This theoretical oxygen demand for the 0.5 gram samples of residual industrial-grade NC would have been 1181 mg/L. Since the residual sample was thoroughly rinsed before biological treatment, the observed oxygen demand was probably not due to solubilized organics on the particulate NC. In addition, previous studies have shown that unaltered NC is not readily susceptible to biodegradation. This observed oxygen demand, therefore, must have been due to biological oxidation of altered NC. This conclusion is further supported by the difference in oxygen demand between the 1 and 4 percent treated samples. Hydrolysis at 4 percent NaOH resulted in a 5-day BOD of approximately 65 mg/L, while the sample treated with 1 percent NaOH resulted in a 5-day BOD of only 30 mg/L. Thus, as the severity of the hydrolysis conditions were increased, alteration of the residual solids also increased, resulting in increased biodegradability.

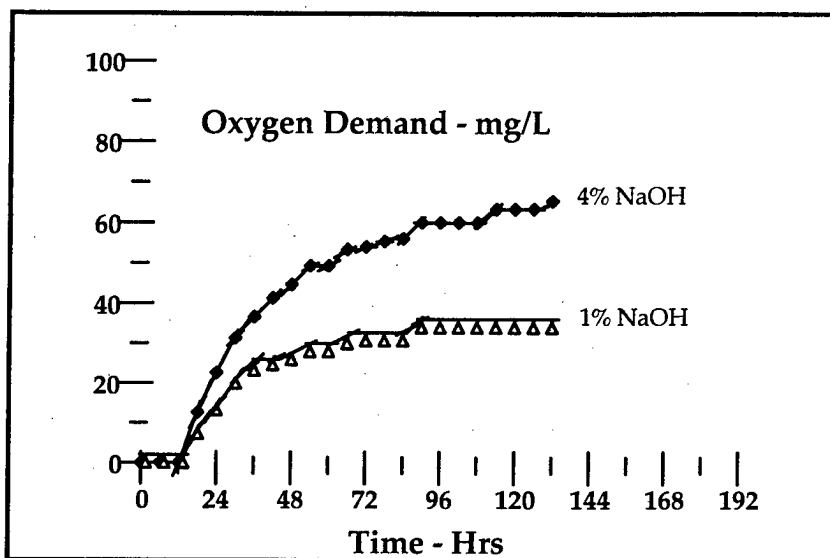

Figure 17. BOD of post-hydrolysis solids.

BOD measurements obtained using the complete post-hydrolysis solution were considerably higher, with readings of approximately 200 and 475 mg/L for hydrolysis at the two caustic concentrations. The results of these studies are presented in Figure 18.

While these BOD values again represented only a fraction of the potential oxygen demand, they nonetheless demonstrated the susceptibility of these post-hydrolysis organics to aerobic biodegradation. It can thus be concluded that under even these minimum hydrolysis conditions, both the soluble and residual solid organics are partially biodegradable, and that this apparent biodegradability increases with the severity of the hydrolysis.

Impact of Post-Hydrolysis Neutralization on Nitrogen Analysis

During the preliminary hydrolysis studies, it was observed that neutralization of the hydrolysate using concentrated sulfuric acid resulted in an apparent loss of nitrogen species from solution. This loss of nitrogen was evidenced by a decrease in nitrite and nitrate concentrations measured by the ion chromatograph and by the formation and release of a "brownish" gas immediately on neutralization with the concentrated acid.

While attempts to quantify this loss were not made, it appeared to be dependent on the final pH of the hydrolysate and on the concentration of the acid used for neutralization. At high pH values (i.e., greater than 11), the concentration of nitrite as a percentage of the combined nitrite and nitrate concentration approached 70 to 80 percent. As the pH of the solution decreased, not only did

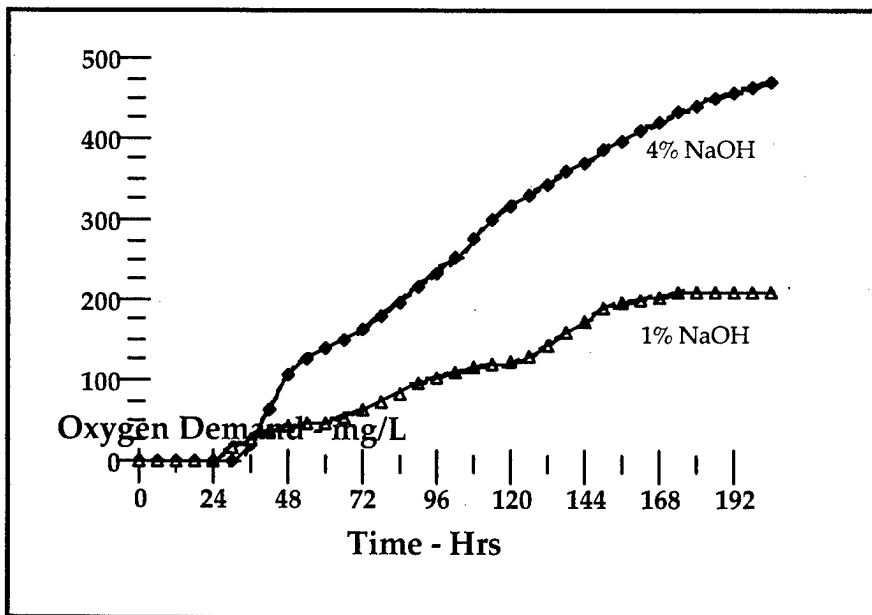

Figure 18. BOD of the complete post-hydrolysis liquor.

the nitrite fraction of the total nitrogen decrease, but so did the total nitrogen concentration. At pH values less than 3, the nitrite fraction of the hydrolysate approached 55 percent of the combined nitrite and nitrate concentration.

The release of the gaseous nitrogen species was especially evident when the very concentrated caustic solutions (i.e., 5-10 percent NaOH), were neutralized using the concentrated acid. This apparent reductive denitration was believed to be a localized phenomenon caused by heat generation and low pH values at the point of acid addition. When the neutralization procedure was modified by decreasing the rate of acid addition, increasing the mixing speed or diluting the acid, the homogeneity of the solution was increased and the gaseous release was not observed.

In subsequent hydrolysis studies using the munitions-grade NC, the neutralization procedure was altered. In those studies used to determine the denitration kinetics, samples were not neutralized before analysis for nitrite and nitrate, thus preserving their original compliments of these species. Instead, these samples were diluted 50 to 70 times using distilled water and filtered before analysis. In all remaining tests where neutralization was necessary, very dilute acid solutions were used. By using the dilute acid, not only was the real world scenario more closely approximated, but the heat generation was also avoided.

Hydrolysis Optimization and Kinetic Studies

Plackett-Burman Statistical Screening

Figure 19 shows the results of the 12-trial Plackett-Burman statistical screening test, conducted using munitions-grade NC. The highest percent TSS solubilization (100 percent) was achieved in trials 4 and 5. Trial 4 corresponds to the high caustic dose, high temperature, high reaction time, and low initial TSS concentration, while trial 5 corresponds to the low caustic dose, high temperature and reaction time, and low initial TSS concentration. Four additional trials resulted in a TSS solubilization greater than 99.7 percent. The lowest percent TSS solubilization (4.2 percent) occurred in trial 7, which employed low caustic dose, low temperature, low reaction time, and high initial TSS concentration.

Before statistical data analysis could be performed, it was necessary to compute the standard error of the main effects, otherwise referred to as test parameters. Columns 5 through 8 in Table 10 and Table 13 represent the four unassigned columns necessary to estimate the experimental error of the test. Since they are not associated with any specific design parameter, the main effect of columns X5, X6, X7, and X8 should theoretically be zero. As a result, these columns can be used to reflect the uncertainty of the data.

Table 13 illustrates how the data collected from the experimental trials can be used to calculate the relative magnitude of each main effect, as well as the experimental error. The Avg (+) represents the average TSS solubilization for all trials in which the given parameter was set at the high level. Likewise, the Avg (-) represents the average TSS solubilization for all trials in which the given

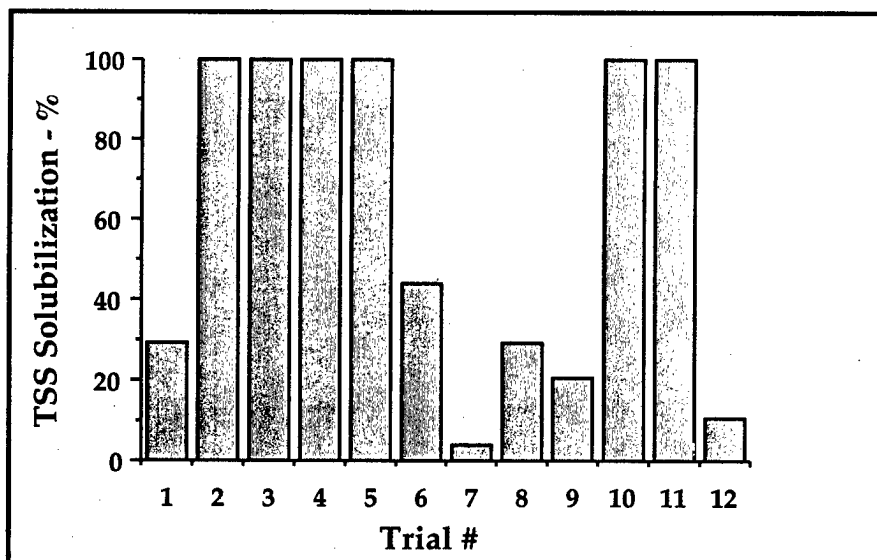

Figure 19. Results of the Plackett-Burman screening test.

Table 13. Calculation of the magnitude of the main effects and the experimental error.

Trial #	Time X1	Temp X2	NaOH X3	NC X4	X5	X6	X7	X8	% TSS Sol.
1	+	+	-	+	+	+	-	-	29.1
2	+	-	+	+	+	-	-	-	99.9
3	-	+	+	+	-	-	-	+	99.7
4	+	+	+	-	-	-	+	-	100.0
5	+	+	-	-	-	+	-	+	100.0
6	+	-	-	-	+	-	+	+	44.1
7	-	-	-	+	-	+	+	-	4.23
8	-	-	+	-	+	+	-	+	29.4
9	-	+	-	+	+	-	+	+	20.4
10	+	-	+	+	-	+	+	+	99.8
11	-	+	+	-	+	+	+	-	99.9
12	-	-	-	-	-	-	-	-	10.4
Avg (+)	78.8	74.8	88.1	58.8	53.8	60.4	61.4	65.6	
Avg (-)	44.0	48.0	34.7	64.0	69.0	62.4	61.4	57.2	
Diff.	34.8	26.9	53.4	5.13	15.2	2.02	0.00	8.33	
Standard Error		8.73							
test statistic		2.78							
t x SE		24.2							

parameter was at the low setting. The absolute difference between these two values is calculated for each column and listed accordingly.

It is important to understand that the last four columns represent the experimental error. The calculated absolute difference values recorded for these columns were used to calculate the standard error. Since four error columns were used, there were four degrees of freedom. To compute the standard error, the sum of the squares of the absolute difference values for columns 5 through 8 was divided by the number of degrees of freedom (four). The square root of this value then represents the standard error of the main effects.

The student's T-test was then applied to test for statistically significant effects. A table of critical values for this distribution, along with the calculated standard error, was used to compute the 95 percent confidence interval for each main effect. Figure 20 depicts the absolute magnitude of each main effect, as calculated in Table 13. The associated 95 percent confidence interval is represented by the horizontal line at 24.2 percent TSS solubilization. Thus, any main effect having an absolute magnitude greater than 24.2 is considered statistically significant.

It is apparent from Figure 20 that caustic dose, time, and temperature are all statistically significant parameters in the solubilization of the nitrocellulose. The caustic dose had the greatest statistical impact on the solubilization,

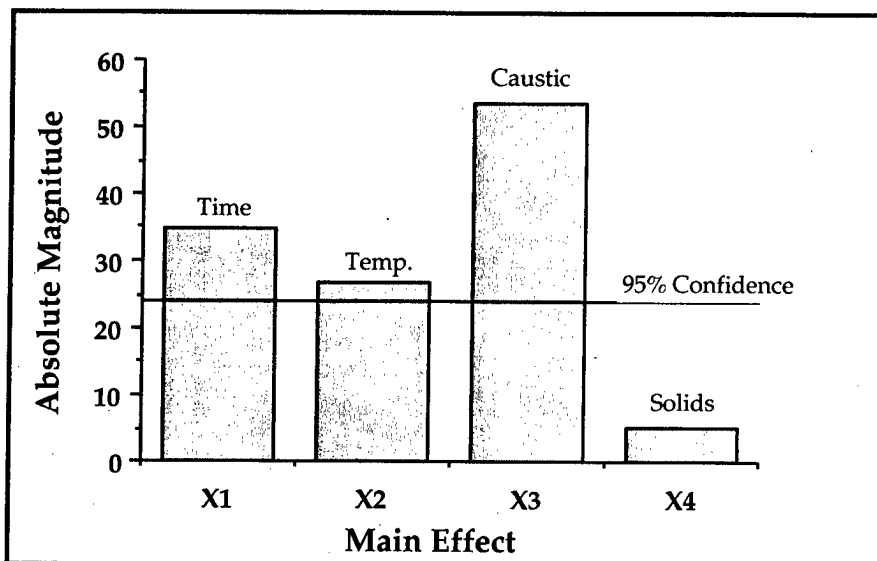
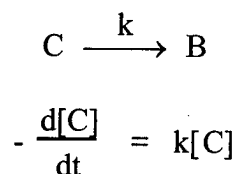

Figure 20. Determination of the statistical significance of each main effect.

followed by the reaction time. Of the significant parameters, temperature had, statistically, the least effect. However, of the two trials resulting in 100 percent solubilization, one employed high caustic/high temperature, while the other employed low caustic/high temperature. This would appear to suggest that temperature, and not caustic, was the most significant parameter.

Kinetic Studies

Following the protocol set forth in Table 11, a series of kinetic studies was next completed for both the solubilization and the denitration of the munitions-grade NC. Various authors (Saeman 1945; Grethlein 1975; Lure et al. 1991) have found that the acid hydrolysis of both cellulose and nitrocellulose follows first-order kinetics. This chemical reaction can be summarized as follows:



where [C] is the molar concentration of cellulose, and k is called the first-order rate constant. The rate has units of M sec⁻¹ if k has units of sec⁻¹.

Since it is believed that the mechanisms involved in the alkaline hydrolysis of cellulose and nitrocellulose are similar to those involved in the acid hydrolysis of these materials, first-order kinetics were anticipated during the solubilization and denitration studies.

Figure 21 shows the results of the first set of tests, conducted to determine the reaction order on hydroxide for the solubilization reaction. These tests were conducted using a NC concentration of 10,000 mg/L and NaOH concentrations ranging from 20,000 to 120,000 mg/L (0.5 to 3.0 M).

In this figure, the plots of $\ln [TSS]$ versus time are linear over the entire caustic range tested, thus confirming the initial assumption of first-order kinetics. The reaction order on hydroxide was then determined by plotting the natural log of these slopes versus the natural log of the molar hydroxide concentration. These results are presented in Figure 20. The slope of this line, shown in Table 12, is equivalent to the reaction order on hydroxide for the solubilization reaction.

As already stated, the solubilization reaction appeared to be first-order. However, the reaction is actually a pseudo-first-order reaction. Because the hydroxide is initially added in excess, it does not vary as the reaction progresses, and therefore can be regarded as a constant. This constant hydroxide concentration can thus be incorporated into the first-order rate constant (k_{OH}), resulting in an observed rate constant (k_{obs}). The pseudo-first-order reaction incorporating the hydroxide concentration follows:

$$-\frac{d[NC]}{dt} = k_{obs} [NC]$$

$$k_{obs} = k_{OH} [OH]^{1.30}$$

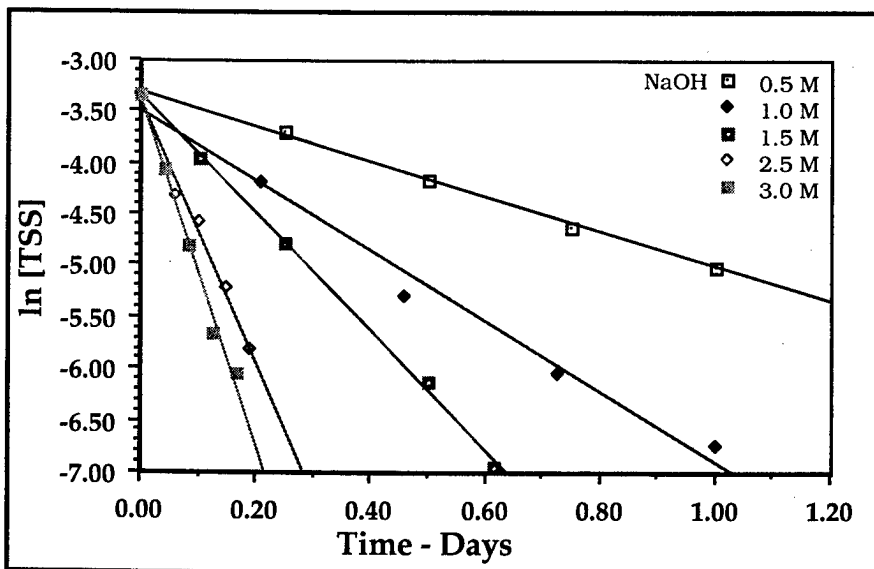

Figure 21. $\ln [TSS]$ versus time, as a function of caustic dose.

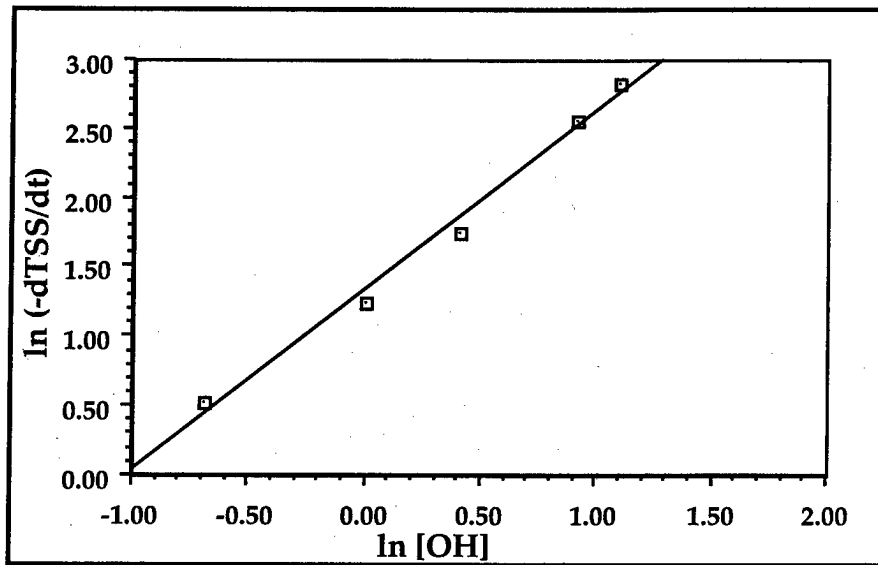

Figure 22. $\ln(-d[TSS]/dt)$ versus $\ln [OH^-]$.

Table 14. Analysis for determination of hydroxide order for solubilization.

Y-Intercept	Slope	R
1.33	1.30	0.99

In this case, [NC] represents the molar concentration of nitrocellulose. However, since all of the suspended solids present in solution are nitrocellulose, [NC] equals [TSS]. The integrated rate law expression for this reaction follows:

$$\ln [TSS] = \ln [TSS_0] - k_{obs} t$$

Once the hydroxide reaction order was determined, and the integrated rate law expression was developed, the next step was to determine the effect of temperature on the solubilization rate. The results of these studies are presented in Figure 23.

Regression analysis was applied to the individual temperature plots to determine the values of k_{obs} and k_{OH} as a function of the reaction temperature. The solubilization rate constants are presented in Table 15.

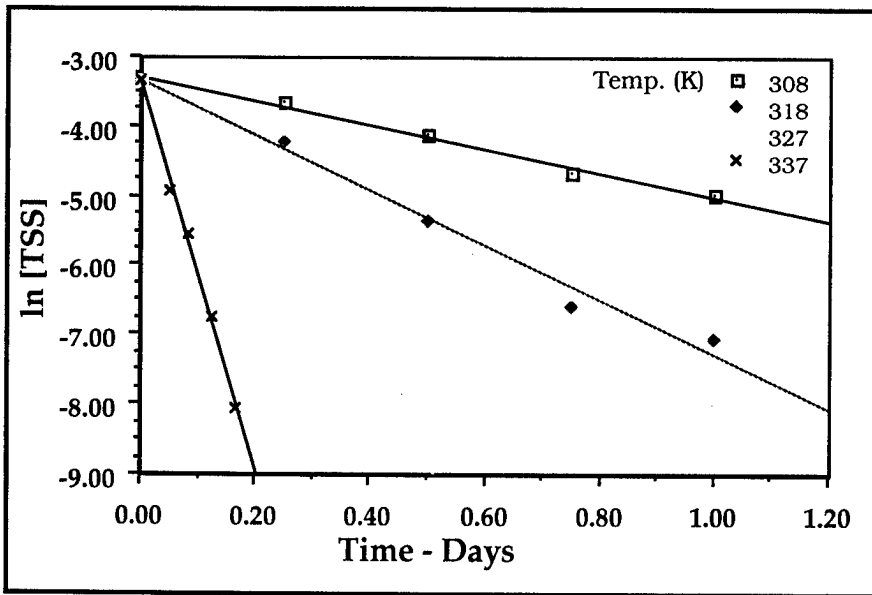

Figure 23. $\ln [TSS]$ versus time, as a function of temperature.

Table 15. Solubilization rate constants.

Temp. (°C)	Temp. (°K)	$\ln [TSS_0]$	k_{obs} (day ⁻¹)	k_{OH} (day ⁻¹)
35	308	-3.30	1.71	4.20
45	318	-3.35	3.93	9.64
54	327	-3.36	11.02	27.05
64	337	-3.35	27.82	68.27

The effect of the reaction temperature on rate constants can be represented by the equation proposed by Arrhenius (1889):

$$\frac{d \ln k_{OH}}{d (1/T)} = - \frac{E_a}{R}$$

In this equation, E_a is the activation energy, R is the gas constant, and T is the absolute temperature. If E_a can be regarded as a constant, this equation can be integrated to give:

$$\ln k_{OH} = \ln A - \frac{E_a}{RT}$$

The term A in this equation is called a "frequency factor," with units of day⁻¹ for first-order rate constants. A linear plot of $\ln k_{OH}$ versus $1/T$ yields the activation energy. Figure 24 shows the results of this plot.

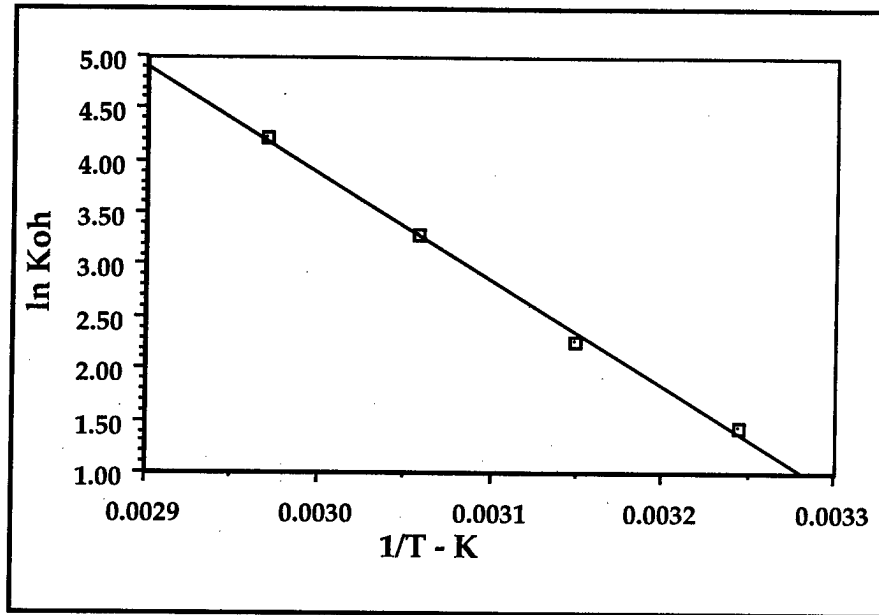

Figure 24. In KOH versus 1/T (°K).

Table 16. Arrhenius factors for the solubilization of nitrocellulose.

A (day ⁻¹)	Ea (kJ/mol)	R (kJ/mol-deg)
1.09 E15	85.22	0.008314

By applying linear regression analysis to the plot of ln kOH versus 1/T, the Arrhenius factors A and Ea were determined for the solubilization reaction. Table 16 lists the results of this analysis.

Following the same procedures used for the determination of solubilization rate constants, rate constants for the denitration reaction were also determined. However, where the loss of TSS was measured for solubilization kinetics, the accumulation of nitrite and nitrate in the hydrolysate represented denitration. Based on the loss of nitrite observed on neutralization in the preliminary studies, these samples were not neutralized before analysis, thus preserving the combined nitrite and nitrate nitrogen concentration present in the hydrolysate.

Figure 25 shows the results of the first set of denitration tests. These tests were conducted using a nitrocellulose concentration of 10,000 mg/L and NaOH concentrations ranging from 20,000 to 100,000 mg/L (0.5 to 2.5 M).

Figure 26 shows a linear plot of the slopes of these individual caustic dependent reactions versus the natural log of the hydroxide ion concentration. The slope of the line formed by these points (Table 17) is equivalent to the reaction order on the hydroxide ion for the denitration reaction.

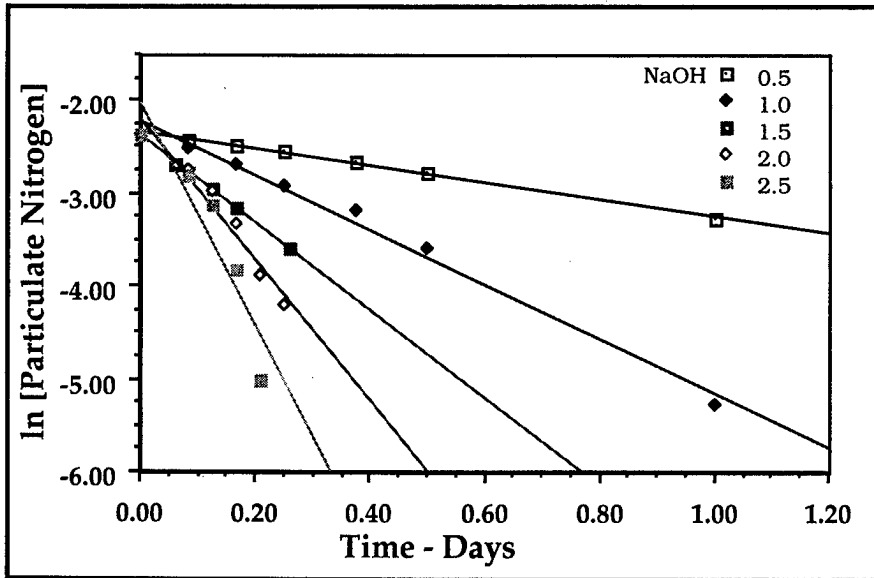

Figure 25. $\ln [N]$ versus time, as a function of caustic dose.

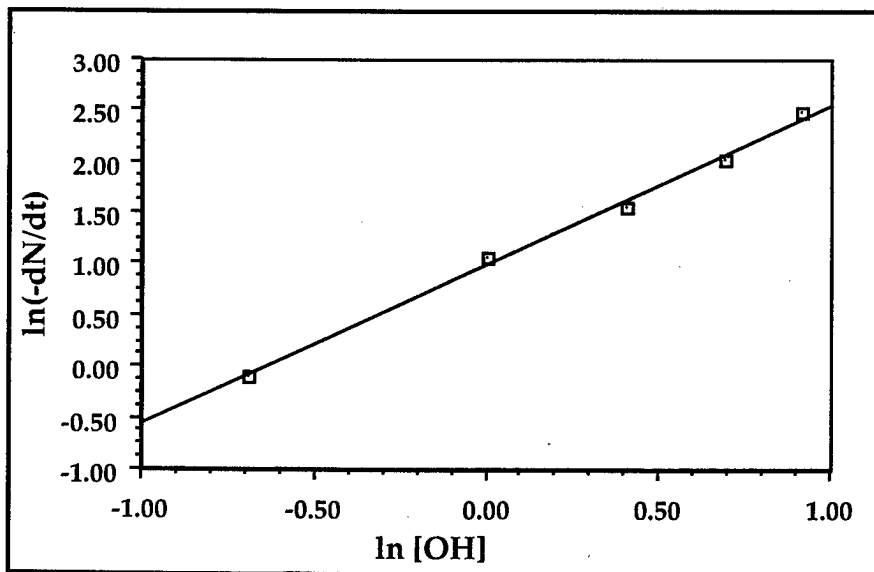

Figure 26. $\ln (-dN/dt)$ versus $\ln [OH]$.

Table 17. Analysis for the determination of hydroxide order for denitration.

Y-Intercept	Slope	R
1.00	1.55	1.00

As with the solubilization reaction, once the hydroxide reaction order was determined, the next step was to determine the effect of temperature on denitration. Figure 27 shows the results of these tests.

Next, the values of k_{obs} and k_{OH} were determined by applying regression analysis to the plots of the individual temperature-dependent denitration reactions. Table 18 lists the results of this analysis.

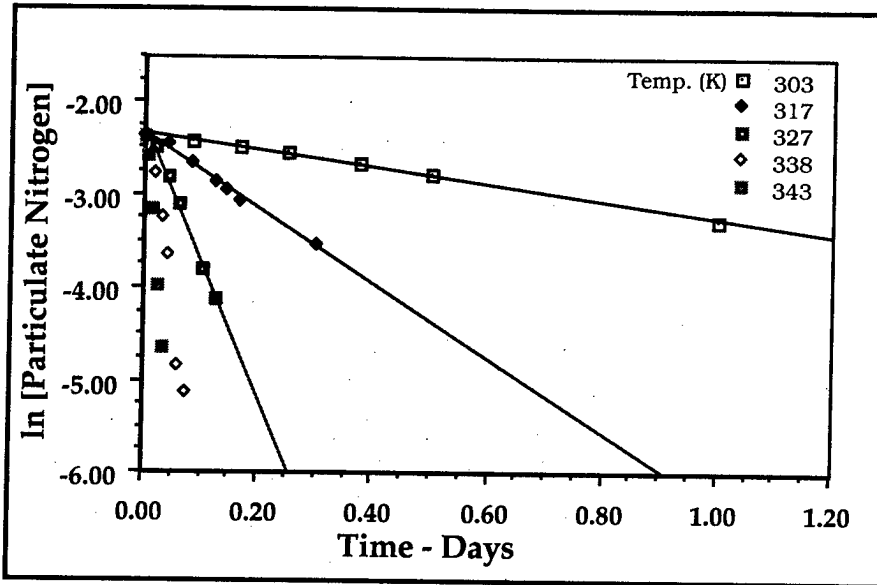

Figure 27. $\ln [N]$ versus time, as a function of temperature.

Table 18. Denitration rate constants.

Temp. (°C)	Temp. (°K)	$\ln [NO]$	k_{obs} (day ⁻¹)	k_{OH} (day ⁻¹)
30	303	-2.33	0.91	2.68
44	317	-2.35	4.01	11.77
54	327	-2.25	14.60	42.82
65	338	-2.11	40.61	119.08
70	343	-2.20	74.22	217.61

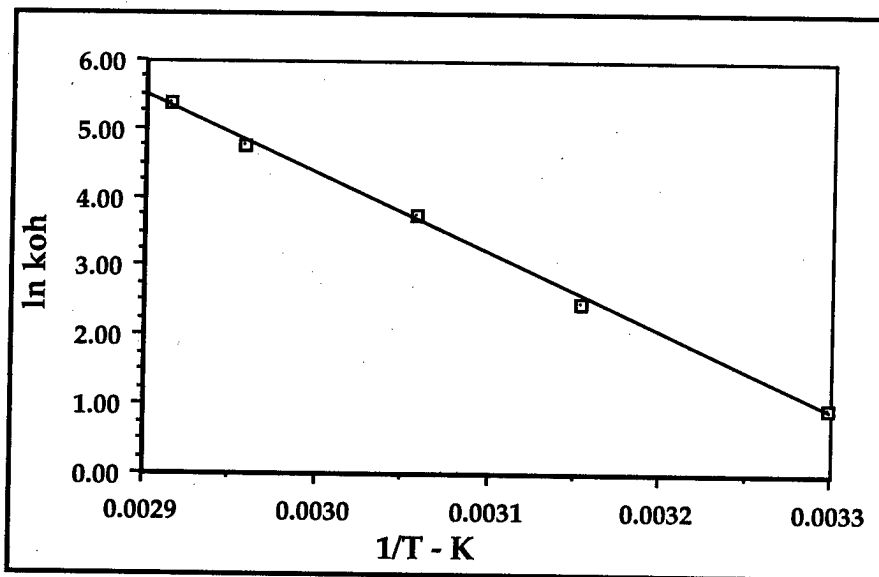

Figure 28. $\ln k_{OH}$ versus $1/T$ (°K).

The Arrhenius constants "A" and "Ea" for the denitration reaction were then determined by plotting the natural log of k_{OH} versus $1/T$ (°K). Figure 28 shows the results. Table 19 lists the values of the Arrhenius constants for the denitration reaction.

Table 19. Arrhenius factors for the denitration of nitrocellulose.

A (day ⁻¹)	Ea (kJ/mol)	R (kJ/mol-deg)
6.13 E16	95.11	0.008314

Predictive Model

Empirical models predicting both the solubilization and the denitration of the munitions-grade nitrocellulose were developed by incorporating the rate constants, determined in the preceding section, into the integrated rate law expressions for the pseudo-first-order reactions. These models are presented below:

Residual Particulate NC (mg/L) =

$$NC_0 \text{ (mg/L)} \times e^{-1.09 \text{ E15} \times e^{-\left[\frac{85.22}{0.008314 \times T}\right]}} \times [\text{OH}]^{1.30} \times \text{time (days)}$$

Residual Particulate Nitrogen (mg / L) =

$$\left[NC_0 \text{ (mg / L)} \times 0.1315 \right] \times e^{-6.13 \text{ E16} \times e^{-\left[\frac{95.11}{0.008314 \times T}\right]}} \times [\text{OH}]^{1.55} \times \text{time (days)}$$

where NC is the initial nitrocellulose concentration in mg/L, [OH] is the molar hydroxide concentration, T is the absolute temperature in Kelvin, and time is the reaction time in days.

To determine the accuracy of these models in predicting the actual solubilization and denitration of the nitrocellulose, experimental versus predicted rates were plotted for various temperatures and caustic concentrations. For the denitration reaction, hydrolysate nitrogen was plotted as opposed to residual nitrogen. This value was determined by subtracting the residual nitrogen concentration from the total available nitrogen.

Predicted versus actual solubilization curves for an intermediate temperature/low caustic combination, and a low temperature/intermediate caustic combination are presented in Figures 29 and 30, respectively. The experimental data points displayed in these figures were developed following the same protocol, but independently of the data used to develop the empirical models. Therefore, it can be concluded, because of the goodness of fit between the predicted and experimental points, that the model developed for the solubilization was substantially correct.

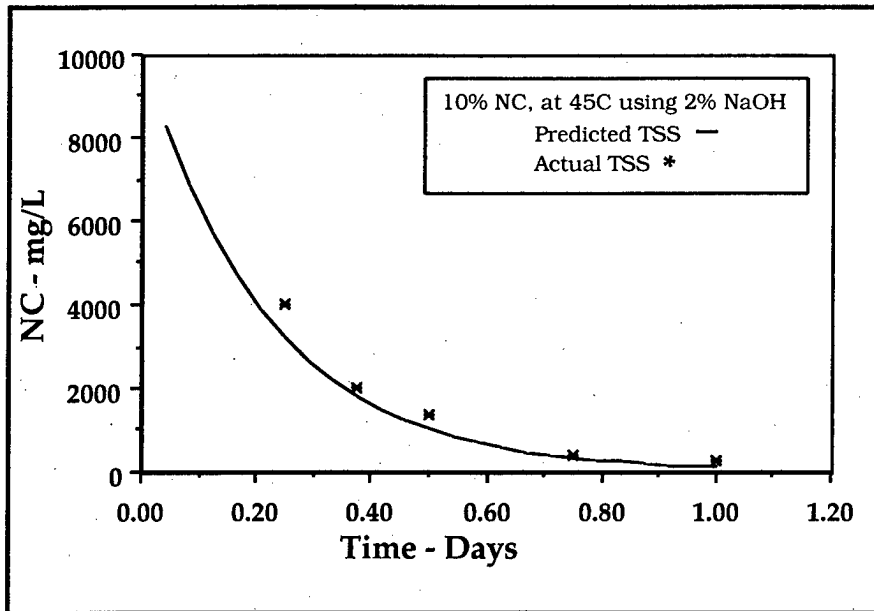

Figure 29. Solubilization prediction for an intermediate temperature/low caustic combination.

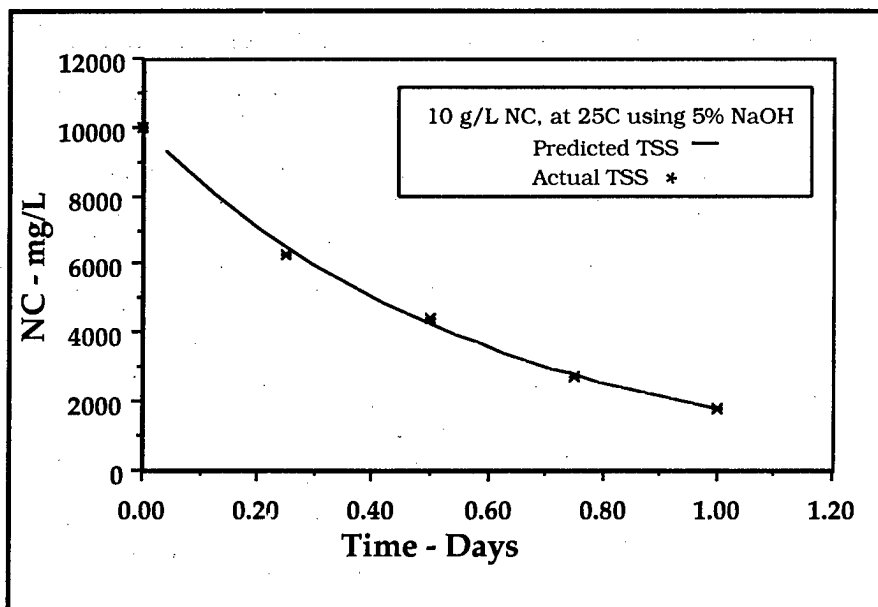

Figure 30. Solubilization prediction for a low temperature/intermediate caustic combination.

Experimental data was also plotted against the predicted results for the denitration reaction. These results are presented in Figure 31. As indicated by this figure, the model for the denitration reaction also appears to accurately predict the reaction. To determine the rate of denitration relative to that of solubilization, it was necessary to plot the predicted value of the remaining solids and remaining nitrogen together. These results are presented in Figure 32. The denitration reaction appears to slightly faster than the solubilization reaction.

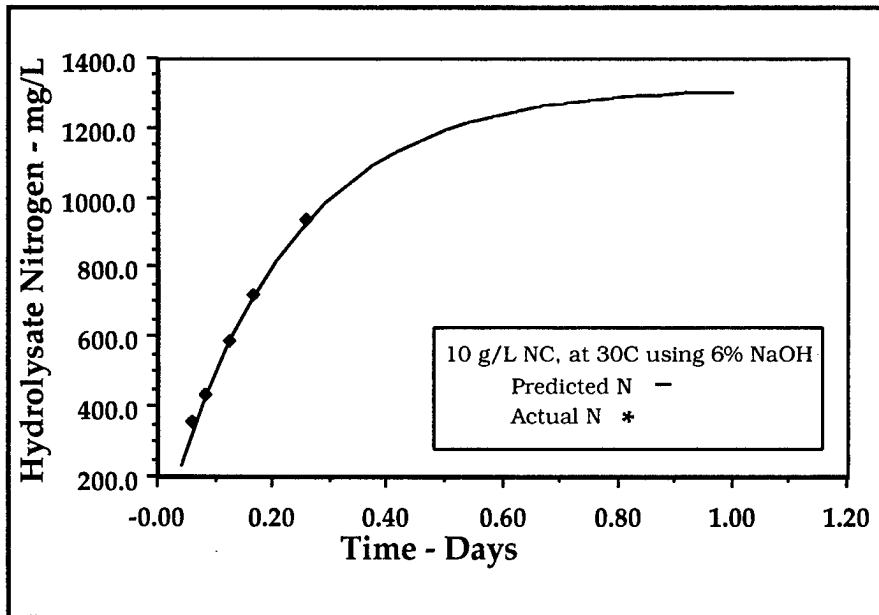

Figure 31. Denitration prediction for a low temperature/intermediate caustic combination.

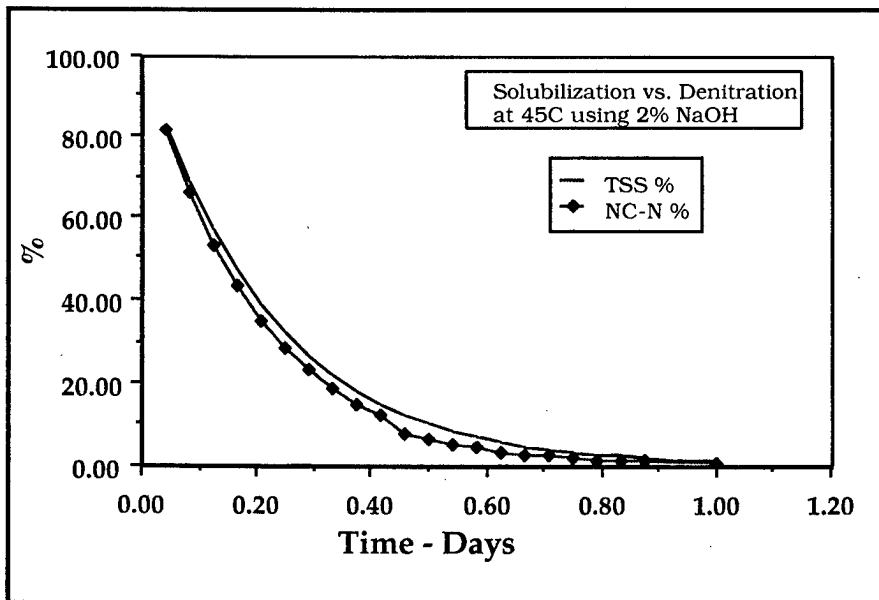

Figure 32. Simultaneous solubilization and denitration.

However, because the two curves are so closely related, the reactions could be considered simultaneous. This conclusion would tend to support the mechanisms proposed by Miles (1955) for the acid hydrolysis of nitrocellulose, but is in disagreement with the conclusion of Lure et al. (1991), again for the acid hydrolysis of NC, that the denitration reaction was much faster than the degradation, or hydrolysis, reaction.

Chemical Characterization of the Hydrolysate

Following the determination of reaction rates for the degradation of the NC, studies were conducted to gain insight into the mechanisms involved in this degradation and the chemical character of the resulting hydrolysate.

Molecular Weight Distribution Studies

The determination of the average molecular weight (MW) of the hydrolysate samples as a function of the hydrolysis time, was deemed an important first step in understanding both the mechanisms involved and the products formed during the reaction. Figures 33 and 34 present the results of the molecular weight distribution studies.

All of the MW distribution tests were conducted on hydrolysates containing 10,000 mg/L NC. The largest MW cutoff analyzed during these tests was 500,000 amu, which corresponded to a filter pore diameter of 0.45 μm (Osmonics, Inc. 1984). The MW fraction greater than this 500,000 amu value contained both soluble and particulate nitrocellulose.

Figure 33 (a) through 33 (c) present the results of the molecular weight distribution tests performed on a hydrolysate sample following hydrolysis at 30 °C. It is evident from this figure that the average molecular weight of the hydrolysate decreased as the hydrolysis time increased. In addition, there was a steady shift to lower molecular weights as the caustic concentration increased from (a) 2 percent NaOH to (c) 10 percent NaOH.

At the 2 percent caustic concentration, a hydrolysate sample, taken after 1 hour of digestion, showed 90 percent of the available carbon being contained in species with molecular weights greater than 500K amu ($>0.45\mu\text{m}$), while 8 percent had weights less than 3K amu. However, after approximately 23 hours of digestion, only 46 percent of the carbon was found in these larger species, while 47 percent was present in species with molecular weights less than 3K amu. Digestion at a 10 percent caustic concentration resulted in 40 and 19 percent of the available carbon being contained in species with molecular weights greater than 500K amu, while 48 and 73 percent was found in species smaller than 3K amu, following digestion for 1 and 20 hours, respectively.

Hydrolysis at 70 °C resulted in similar trends, however, the shift toward the lower molecular weights was much more dramatic. Figure 34(a) and 34(b) show the results of these studies.

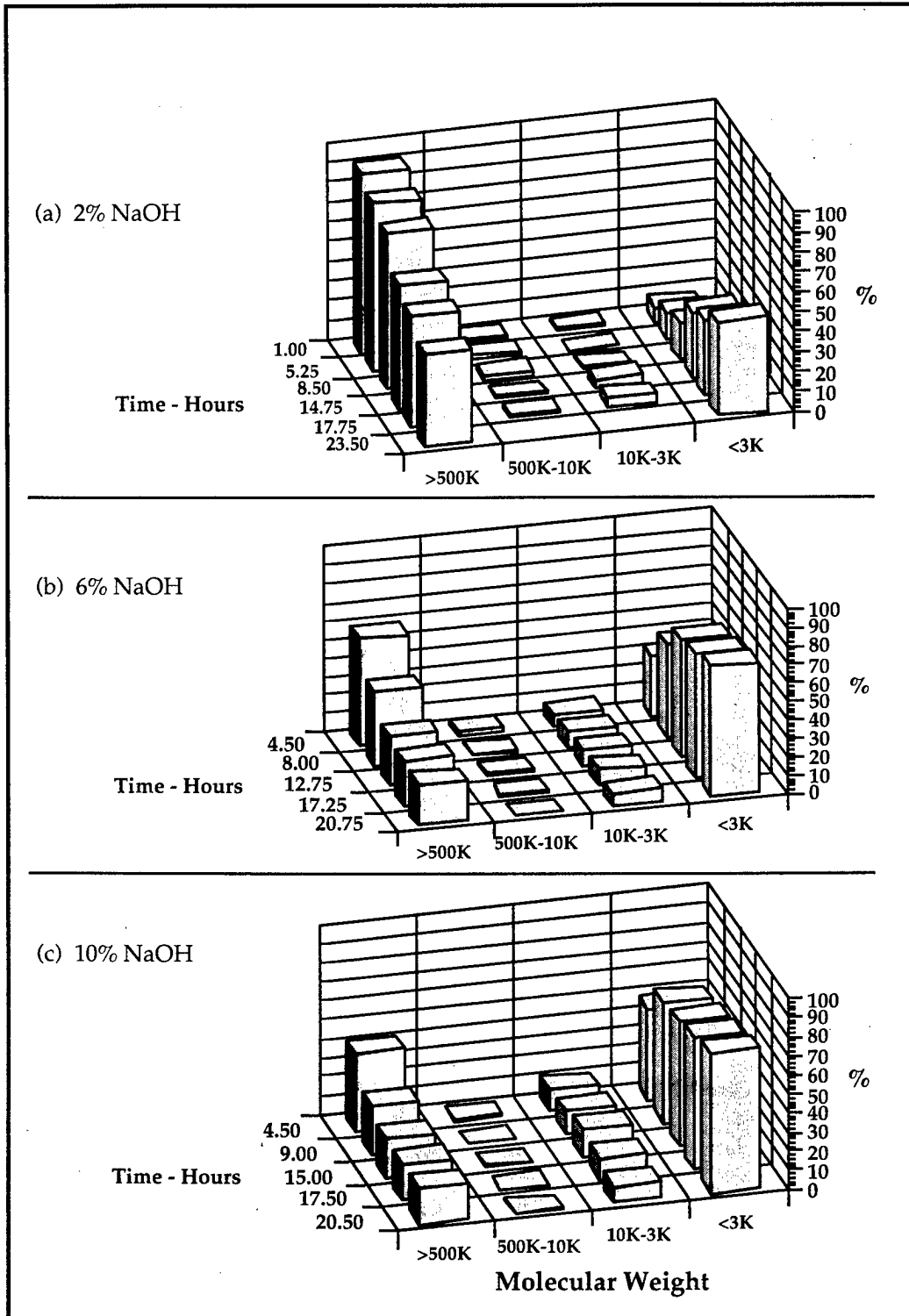

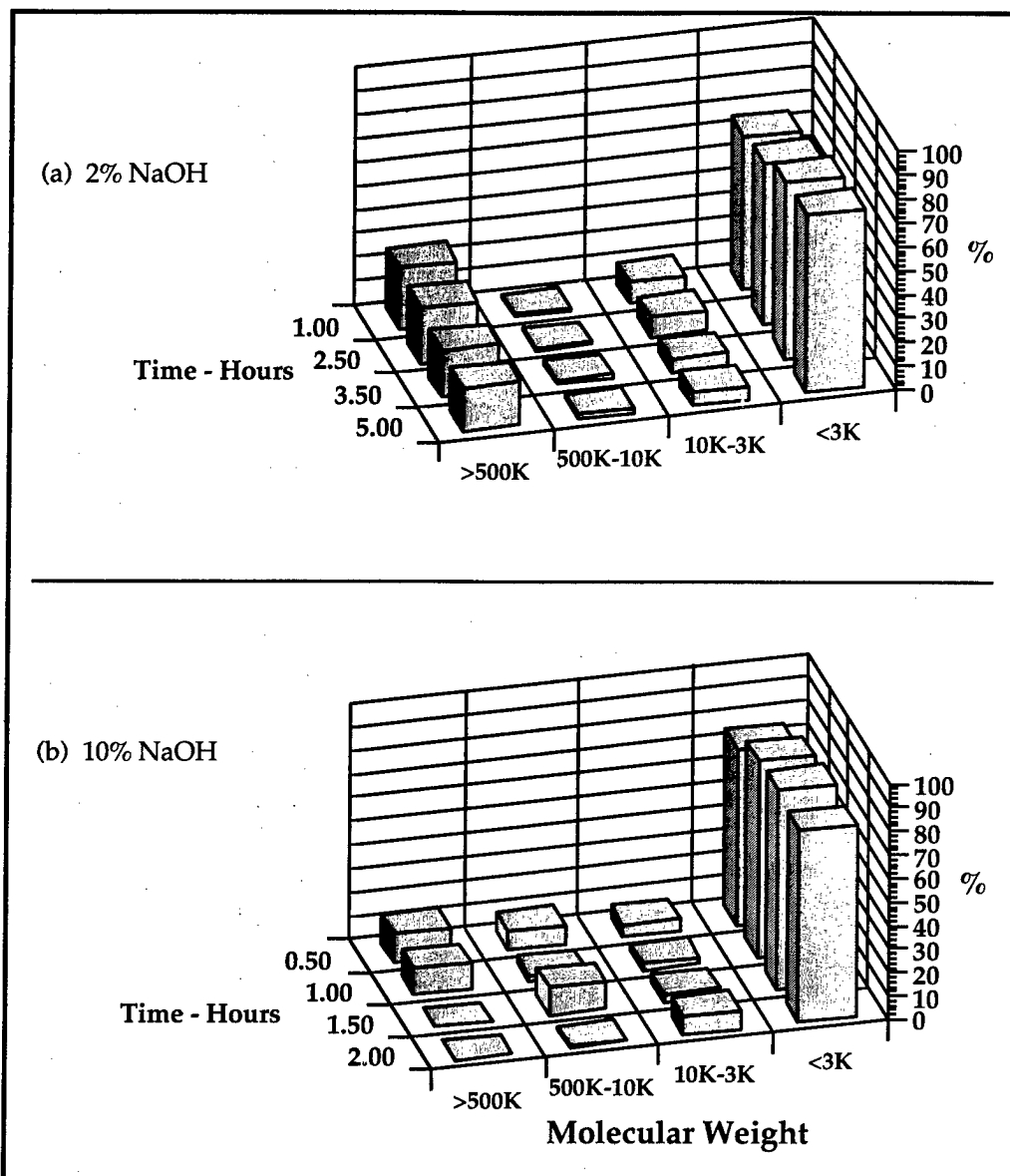

Figure 34. Molecular weight distributions of hydrolysate following 70 °C digestion at: (a) 2% NaOH, (b) 10% NaOH.

The average molecular weights for these samples decreased rapidly following a relatively short reaction period. The percent of the available carbon found in the smaller molecular weight species ranged from 65 to 74 percent, following digestion at a 2 percent caustic concentration for periods of 1 and 5 hours, respectively. At the 10 percent caustic concentration this shift was even more significant, with 81 percent of the carbon being found in species smaller than 3K amu's after only 2 hours of hydrolysis.

The finding that a predominant fraction of the hydrolysate was composed of either very large species or relatively small molecular weight species, with only a trace falling in the intermediate range, is significant. The hydrolysis mechanisms proposed by Blazej and Kosik (1985), Fan et al. (1987), Hon and

Shiraishi (1990), and Mukherjee and Levine (1992) for the alkaline hydrolysis of pure cellulose offer a possible explanation for this phenomenon.

These authors proposed that the overall degradation progressed by means of three separate reactions: (1) swelling of the structure, (2) hydrolysis of the glucosidic bonds, and (3) peeling and stop reactions.

In the first of these reactions, the structure swells as a result of exposure to the aqueous sodium hydroxide. Swelling acts to increase the surface area of the cellulose, thus increasing its susceptibility to the hydrolysis and peeling reactions. This swelling can be so extensive that complete solubilization occurs. Little is known about the mechanisms involved in the swelling reaction, but it appears to involve the breaking of hydrogen bonds holding the individual cellulose strands together.

The hydrolysis of the glucosidic bonds occurs in the same manner as in acid hydrolysis. The hydrolysis occurs at random along the polymeric chain resulting in numerous chains of reduced molecular weight, each with a reducing terminal group. This hydrolysis reaction appears to be strongly influenced by the severity of the digestion conditions. Thus, as the digestion conditions become more severe, the rate of hydrolysis of the glucosidic bonds also increases.

The third mechanism, peeling, occurs at the newly formed reducing terminal groups. During the peeling process, monomeric units are cleaved from the rest of the polymeric chain, and altered via elimination reactions. The peeling reaction is believed to be the most significant mechanism in the overall process, resulting in the formation of glyceraldehyde, and various organic acids (Hon and Shiraishi 1990).

While the kinetic results presented in the preceding section show the overall degradation reaction to be pseudo-first-order, these studies did not attempt to distinguish which of the individual reactions just described was the rate limiting step in this degradation.

Because the peeling reaction is an endwise degradation, dependent on the presence of terminal reducing groups, it is unlikely that it would be the rate limiting step in the overall degradation. The swelling and hydrolysis reactions, on the other hand, could be rate limiting.

If the hydrolysis of the glucosidic bonds is the rate limiting step, a steady decrease in the molecular weight of the hydrolysate would be expected with increasing hydrolysis severity. However, the molecular weight distribution

results indicate no significant intermediate molecular weight fraction being formed. Under all reaction conditions, the hydrolysate was made up of either large (>500K amu), or small (<3,000 amu) species. In addition, besides being dependent on time, temperature, and the caustic concentration, the hydrolysis rate is also dependent on the accessibility of the cellulose structure. Decreased accessibility of the structure results in the hydrolysis reaction being confined to the exposed surfaces of the polymer, resulting in a decreased rate of hydrolysis just as in enzymatic hydrolysis.

Finally, the swelling reaction could be the rate determining step in the overall alkaline degradation of the nitrocellulose structure. As the swelling increases with the severity of the treatment conditions, hydrolysis of the exposed glucosidic bonds occurs. This results in the rapid formation of a low molecular weight fraction, while the NC, not yet accessible to hydrolysis, remains intact.

Two additional reactions, occurring during the alkaline hydrolysis of NC, but not present during the alkaline hydrolysis of cellulose, are also of possible importance in explaining the MW distribution results. The first, denitration, is not believed to significantly affect the degree of polymerization or cause an alteration of the ring structure. However, the nitrate formed by this denitration would have significant oxidizing capacity.

This newly formed nitrate could cause oxidation at the reducing terminal groups, or elsewhere on the NC structure, resulting in possible depolymerization and/or rupturing of the ring structure, and thus a decrease in the molecular weight. The high concentrations of reduced nitrogen, in the form of nitrite, present in the hydrolysate provides evidence of the possible importance of this reaction. In addition, the apparent loss of a fraction of the total organic carbon from the system as carbon dioxide, provides further evidence of the significance of these redox reactions.

COD and TOC Results

The organic matter present in solution following the alkaline hydrolysis of the munitions-grade NC includes a variety of organic compounds. The COD and TOC analyses were used to estimate the quantity of these compounds, as well as to estimate their average oxidation state following hydrolysis.

The carbon present in the particulate NC, before hydrolysis, is at a zero oxidation state. For this carbon to be completely oxidized, as in the COD test, it must form carbon dioxide (+4 oxidation state). This reaction would create an oxygen demand of 2.667 mg of oxygen per 1 mg carbon oxidized. A 10,000 mg/L

concentration of the munitions-grade NC, as used in all hydrolysis tests, was determined to have, on complete oxidation, a potential oxygen demand of 6,484 mg/L with an associated 95 percent confidence interval of ± 173 mg/L. This same NC solution contained 2,400 mg/L of organic carbon with an associated 95 percent confidence interval of ± 100 mg/L, based on total organic carbon analysis.

Figure 35 (a) through 35(c) show results of the COD tests. These results take into account the oxygen demand of all soluble organic matter in the hydrolysate, including that matter which might not have been biologically oxidizable, as well as the oxygen demand associated with the nitrite contained in the hydrolysate. In these figures, the COD in mg/L versus the hydrolysis time in hours is presented for hydrolysis temperatures of (a) 30 °C, (b) 50 °C, and (c) 70 °C.

Likewise, the results of TOC analysis on these same hydrolysate samples are presented in Figure 36 (a) and 36 (b). While TOC samples covering a range of hydrolysis caustic doses and reaction times were analyzed:

(a) 30 °C, (b) 50 °C, and (c) 70 °C

(a) 50 °C and (b) 70 °C

for the 50 °C and 70 °C hydrolysate temperatures, only two TOC measurements were made on the 30 °C samples. The 30 °C TOC results, therefore, will not be presented graphically, but are included in Table 20. In the two remaining figures, the TOC in mg/L versus the hydrolysis time in hours is presented.

The results of the COD analysis indicated an increase in soluble COD values with increasing time, temperature, and caustic dose, up to an apparent maximum value of approximately 5,800 mg/L for all three temperature variations. On reaching this maximum value, subsequent hydrolysis resulted in a gradual loss of COD under the most extreme hydrolysis conditions.

TOC results followed a trend similar to that of the COD results, with the soluble organic carbon concentrations increasing with the severity of the treatment conditions. On reaching the maximum available carbon concentration of approximately 2,400 mg/L, which would have been achieved following the complete solubilization of the 10,000 mg/L NC samples, continued hydrolysis resulted in an apparent loss of organic carbon from the system.

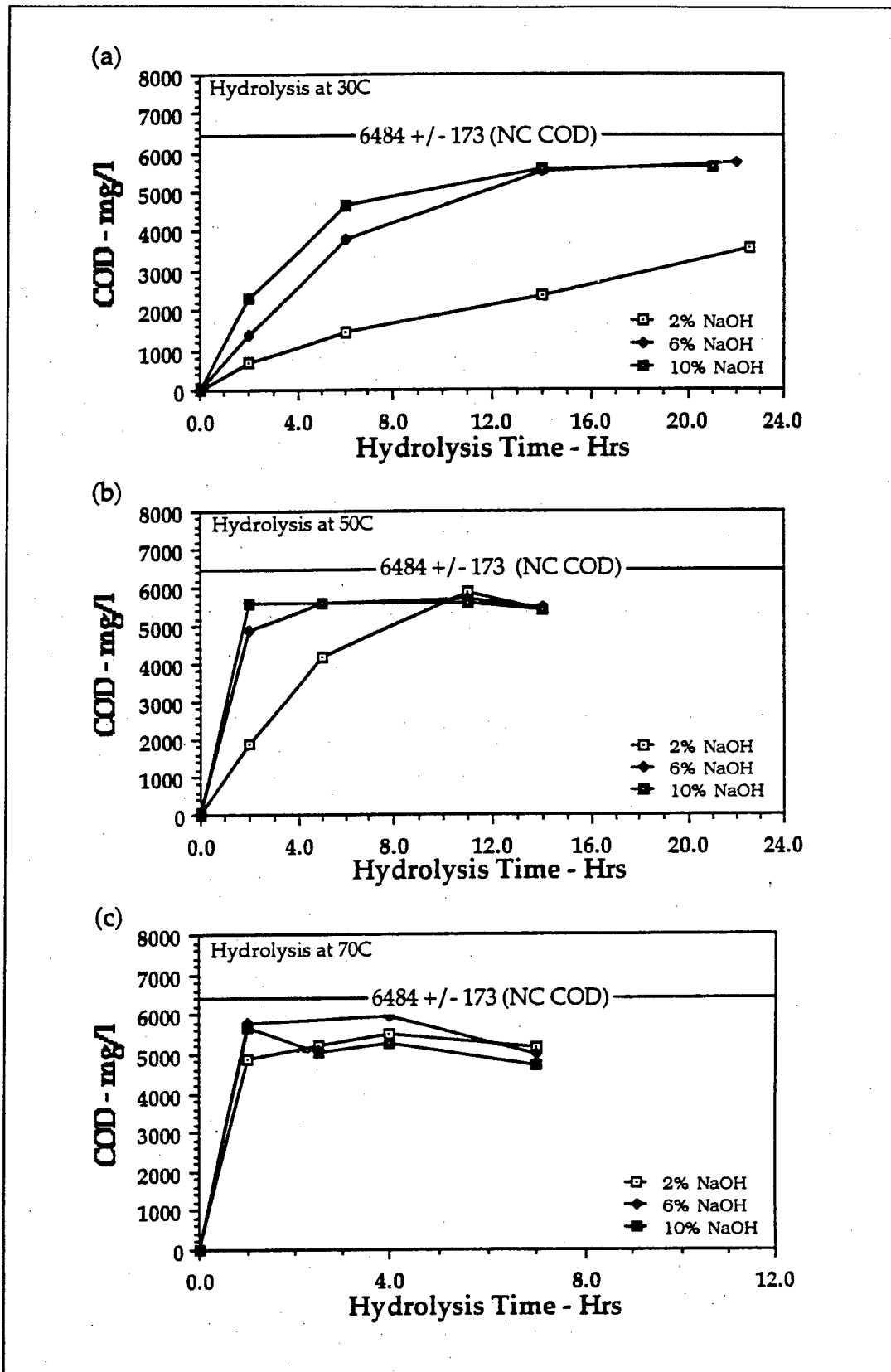

Figure 35. Hydrolysate COD following hydrolysis at (a) 30 °C, (b) 50 °C, and (c) 70 °C.

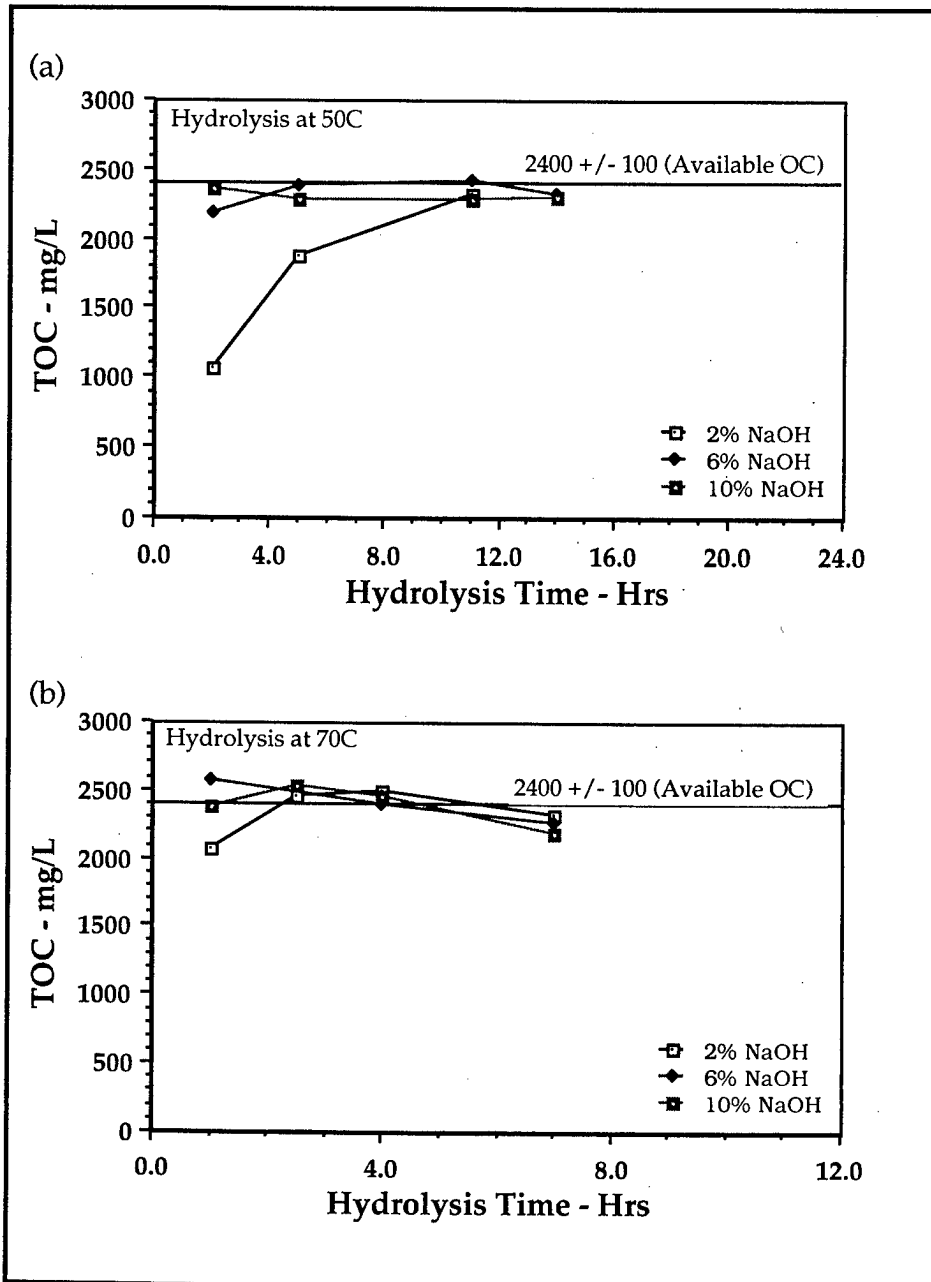

Figure 36. Hydrolysate COD following hydrolysis at (a) 50 °C, and (b) 70 °C.

If the solubilization of the NC was strictly due to the swelling reaction, discussed in the previous section, no alteration of the polymeric chain or the individual ring structures would have been observed, and thus TOC and COD would have been preserved. If this degradation occurred strictly as a result of hydrolysis of the glucosidic bonds, as in the acid hydrolysis of cellulose, the individual glucose monomers would have remained intact, and total carbon would have likewise been preserved.

While the actual TOC plots appear to show a decrease in soluble TOC beyond a certain point in the hydrolysis reaction, this loss was insignificant compared to the experimental error involved in the carbon analysis. Previous authors had found significant quantities of carbon dioxide being produced during this reaction. This finding, however, was not supported by these results which showed hydrolysate TOC and COD values nearly equal to those values determined for the raw NC. The substantial quantities of reduced nitrite-nitrogen present in the hydrolysate did, however, provide evidence for the occurrence of redox reactions on the alkaline hydrolysis of the NC.

To show the extent of these redox reactions, and to provide insight into the composition of these oxidation products, the average oxidation state of the hydrolysate was determined using the following equation, where TOC and COD are given in molar concentrations (Stumm and Morgan 1981):

$$\frac{4 \times (\text{TOC} - \text{COD})}{\text{TOC}} = \text{oxidation state}$$

Table 20. Hydrolysate oxidation state determinations.

Hydrolysis Conditions	COD (mg/L)	NOD (mg/L)	CCOD (mg/L)	TOC (mg/L)	O.S. A	O.S. B
30C, 6%, 6.0 hr	3773	480	3293	1581	0.42	0.88
30C, 6%, 22.0 hr	5772	880	4892	2490	0.52	1.05
50C, 2%, 2.0 hr	1899	610	1289	1055	1.30	2.17
50C, 2%, 5.0 hr	4154	914	3240	1878	0.68	1.41
50C, 2%, 11.0 hr	5877	1168	4709	2329	0.21	0.97
50C, 6%, 2.0 hr	4882	977	3905	2188	0.65	1.32
50C, 6%, 5.0 hr	5564	1182	4382	2379	0.49	1.24
50C, 6%, 11.0 hr	5677	1027	4650	2415	0.47	1.11
50C, 6%, 14.0 hr	5481	959	4522	2320	0.46	1.08
50C, 10%, 2.0 hr	5589	907	4682	2363	0.45	1.03
50C, 10%, 5.0 hr	5563	947	4616	2289	0.35	0.98
50C, 10%, 11.0 hr	5568	967	4601	2291	0.35	0.99
50C, 10%, 14.0 hr	5433	957	4476	2312	0.48	1.10
70C, 2%, 1.0 hr	4885	997	3888	2067	0.46	1.18
70C, 2%, 2.5 hr	5215	1199	4016	2463	0.82	1.55
70C, 2%, 4.0 hr	5476	1199	4277	2488	0.70	1.42
70C, 2%, 7.0 hr	5173	1199	3974	2324	0.66	1.44
70C, 6%, 1.0 hr	5794	1199	4595	2566	0.61	1.31
70C, 6%, 4.0 hr	5950	1085	4865	2400	0.28	0.96
70C, 6%, 7.0 hr	5006	1119	3887	2264	0.68	1.42
70C, 10%, 2.5 hr	5045	1033	4012	2529	1.01	1.62
70C, 10%, 4.0 hr	5251	1141	4110	2450	0.79	1.48
70C, 10%, 7.0 hr	4714	1050	3664	2192	0.77	1.49

Table 20 lists the results of the oxidation state determinations. In this table, two values of the average oxidation state are given. The first, O.S. (A), was determined using the actual oxygen demand of the entire sample as determined by the COD test. The second, O.S. (B), was determined by subtracting the nitrogenous oxygen demand (NOD) from the measured COD, and thus only using the carbonaceous chemical oxygen demand (CCOD) to determine the average oxidation state. The NOD values were determined based on the complete oxidation of all reduced nitrogen in the hydrolysate samples. Since previous tests had indicated that ammonia concentrations in the hydrolysate were insignificant, only nitrite oxidation demand was included in the NOD determination.

It is apparent from these results that the NC carbon underwent oxidation during the hydrolysis process even under the least severe conditions. It is also apparent that while the degradation increased with the increasing severity of the treatment conditions, only a slight increase in the average oxidation state, as evidenced by the O.S. (B) values, was observed.

To confirm the occurrence of these redox reactions, a series of control experiments were undertaken. In these tests, sodium nitrate and glucose were hydrolyzed using sodium hydroxide under the same reaction conditions as used in the NC tests. If redox reactions were not occurring during the hydrolysis, the nitrogen would remain in solution as nitrate, and there would be no evidence that the glucose was oxidized. The results of these tests, however, confirmed the occurrence of the redox reactions. In addition to nitrite being formed, the characteristic brown color associated with the oxidation of sugar was also observed, as had been the case with NC hydrolysis. As the hydrolysis conditions became more severe, the amount of nitrate reduced to nitrite increased while the hydrolysate became progressively darker in color. The results of the control tests are presented in Table 21.

During the control tests, the nitrite-nitrogen fraction of the total available nitrogen concentration, increased as the severity of the hydrolysis conditions increased. Under the least severe conditions tested the nitrite nitrogen accounted for just over 1 percent of the available nitrogen, while under the most severe hydrolysis conditions, nitrite nitrogen made up approximately 38 percent of the total nitrogen. A comparison between these values and those obtained from the actual NC hydrolysis tests (from raw data that are not shown in this report) shows that the nitrite-nitrogen fraction of the combined nitrite and nitrate nitrogen values ranged from 27 percent to approximately 80 percent under the least severe and most severe hydrolysis conditions, respectively. These results support two scenarios for the denitration and oxidation of the NC.

Table 21. Sodium nitrate/glucose alkaline hydrolysis results.

Hydrolysis Conditions	NO ₂ -N (mg/L)	NO ₃ -N (mg/L)
30°C, 2% NaOH, 3 hr	21.3	1,588
30°C, 2% NaOH, 12 hr	244	1,403
30°C, 2% NaOH, 16 hr	305	1,340
30°C, 10% NaOH, 3 hr	77.9	1,340
30°C, 10% NaOH, 12 hr	461	1,186
30°C, 10% NaOH, 16 hr	513	1,130
60°C, 2% NaOH, 1 hr	426	1,225
60°C, 2% NaOH, 2.5 hr	531	1,115
60°C, 2% NaOH, 4 hr	535	1,110
60°C, 2% NaOH, 10 hr	554	1,090
60°C, 10% NaOH, 0.5 hr	515	1,135
60°C, 10% NaOH, 1.0 hr	602	1,040
60°C, 10% NaOH, 1.5 hr	621	1,026
60°C, 10% NaOH, 2.5 hr	623	1,020

Based on the results of the glucose/sodium nitrate tests, it is possible that nitrate groups on the NC structure are being liberated in the usually accepted manner as nitrate. Under the high pH conditions, these nitrate groups then undergo reduction to nitrite with a corresponding oxidation of the NC carbon.

The significant difference in the nitrite fraction observed in the control tests and that observed in the actual NC hydrolysis tests suggests a second reaction. It is possible that a fraction of the available nitrate groups are being liberated from the NC structure as nitrite following the breaking of oxygen-nitrogen bonds. This scenario is supported by the work of Baker and Easty (1950), and would result in the formation of aldehydes and ketones as degradation products.

The average oxidation state of the hydrolysate samples and the possible denitration mechanisms just discussed, support the formation of the hydrolysis by-products reported in previous studies. A few of these by-products, and their corresponding carbon oxidation states, are presented in Table 22.

Table 22. Possible NC degradation byproducts and their corresponding carbon oxidation states.

Carbon Oxidation State	Compound
0	Glucose
0	Glyceraldehyde
+0.17	Isosaccharinic acid
+1	Glycolic acid
+2	Malic acid
+2	Formic acid
+2	Carbon monoxide
+3	Oxalic acid
+4	Carbon dioxide

Carbohydrate Analysis Results

Because glucose, a carbohydrate, is known to be formed on the complete hydrolysis of cellulose, its formation during the alkaline hydrolysis of the munitions-grade NC was anticipated. In addition, the sizable fraction of the available carbon with a relatively low average oxidation state provided further evidence that unoxidized carbohydrates could be present in the hydrolysate.

Residual carbohydrate determinations were made following the procedures set forth in Chapter 3, Analytical Methods, Carbohydrate (i.e., using the phenol-sulfuric test). The phenol-sulfuric acid combination reacts with all simple sugars, oligosaccharides, polysaccharides, and their derivatives, including the methyl ethers with free or potentially free reducing groups. Because the phenol-sulfuric test gives positive readings in the presence of all of these compounds, it was employed as a quantitative tool to determine the concentration of total carbohydrates and related compounds as opposed to a qualitative determination of the actual compounds present. These tests were performed on hydrolysate samples containing 10,000 mg/L munitions-grade nitrocellulose, just as in the COD tests. As discussed in the literature review, both cellulose and NC are composed of glucose monomers attached via B-glucosidic bonds to form the NC polymer. If the alkaline hydrolysis of these glucosidic bonds was 100 percent efficient, hydrolysis of the 10,000 mg/L NC samples would result in the release of the entire complement of carbon, 2,400 mg/L, as glucose. Because the glucose molecule contains 40 percent carbon by weight, this would result in a theoretical carbohydrate yield (as glucose) of 6,000 mg/L. Figure 37 (a) and (b) give the results of these tests. In these figures, total carbohydrates, in mg/L as glucose, are plotted versus the hydrolysis time in hours for hydrolysis temperatures of (a) 30 °C and (b) 70 °C.

The apparent carbohydrate concentrations in the hydrolysate attained a maximum value of approximately 3,800 mg/L following both 30 °C and 70 °C hydrolysis. The rate of carbohydrate formation varied with both the temperature and the caustic concentration. The lower temperature studies showed that this rate of formation increased with increasing caustic concentration, achieving the maximum value following 17.5 hours of digestion. Following the higher temperature hydrolysis, this same maximum value was achieved after only 1 hour of digestion. Continued hydrolysis following attainment of this maximum value resulted in a decline in the carbohydrate concentration.

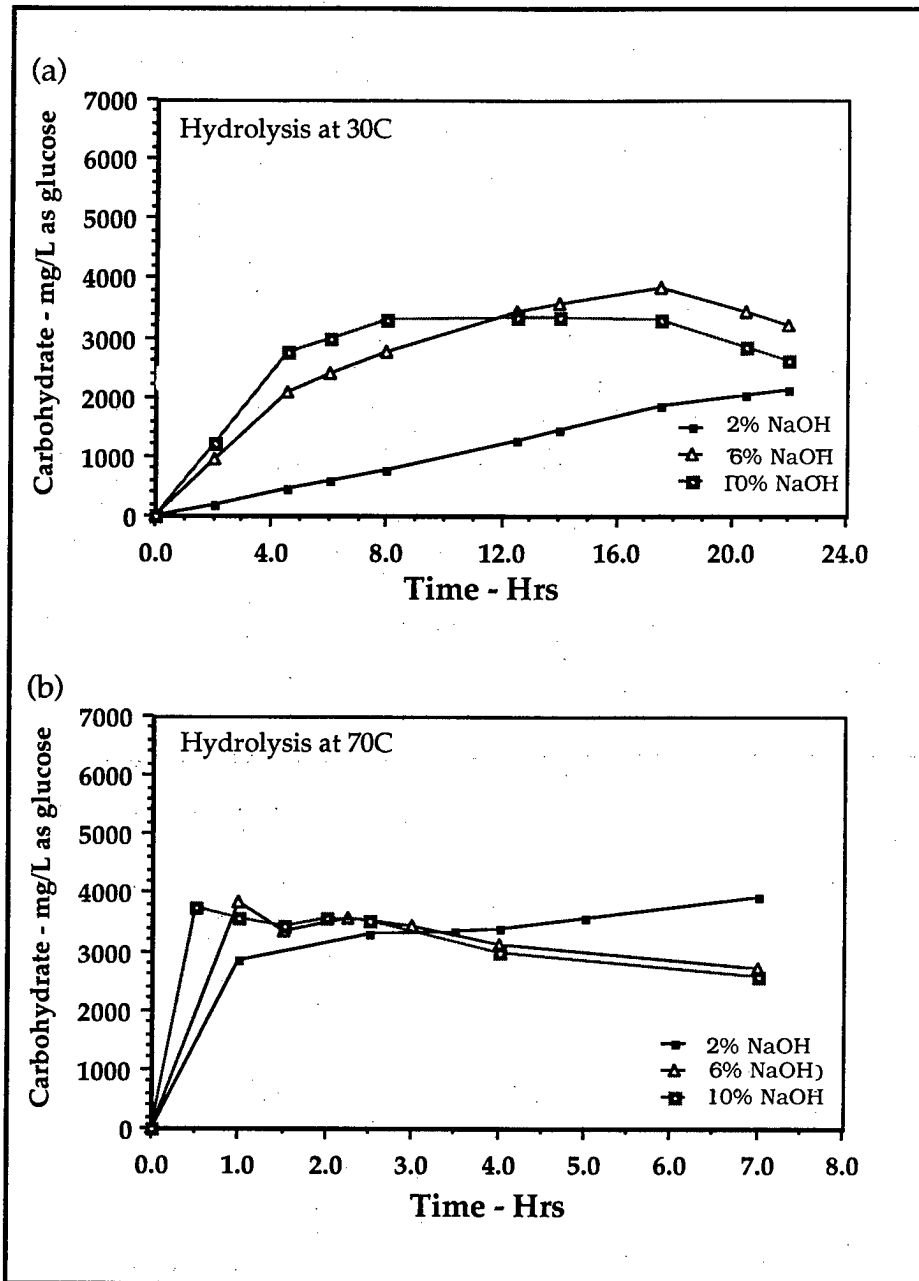

Figure 37. Hydrolysate carbohydrate analysis at (a) 30 °C and (b) 70 °C.

The carbon fraction of the measured carbohydrate values was next compared to the TOC analysis results for these same samples. The carbohydrate carbon fraction of the total organic carbon ranged from 60 percent following hydrolysis at 30 °C in 6 percent NaOH for 6 hours, to 47 percent, obtained following hydrolysis at 70 °C in 10 percent NaOH for 7 hours. This apparent decrease in carbohydrate carbon parallels the observed increase in the average oxidation state of the hydrolysate carbon species and the increase in nitrite nitrogen with increasing caustic concentration and hydrolysis temperature.

The close correlation observed between the carbohydrate graphs at 30 and 70 °C and the COD graphs at 30 and 70 °C (Figure 35), also warranted further analysis. Table 23 contains the carbohydrate values as glucose (Carb), and compares the theoretical oxygen demand of the carbohydrates (CarbOD) with the carbonaceous chemical oxygen demand (CCOD) determined via chemical analysis. It is apparent that the oxygen demand that could be attributed to the oxidation of the carbohydrates makes up a significant fraction of the total oxygen demand associated with carbon oxidation.

While the phenol-sulfuric test usually results in the formation of a yellow-orange color in the presence of the carbohydrates and carbohydrate derivatives mentioned previously, a slight discoloration was observed on analysis of these samples. This discoloration increased as the hydrolysis conditions under which the samples were prepared increased.

Because this discoloration was believed to be due to noncarbohydrate by-products, additional analysis of the hydrolysate samples was warranted. Three hydrolysate samples, representing "minimal" (i.e., 2 percent NaOH, for 2 hours at 30 °C), "intermediate" (i.e., 2 percent NaOH, for 12 hours at 60 °C), and "harsh" (i.e., 10 percent NaOH, for 4 hours at 70 °C) hydrolysis conditions, were prepared. Analysis of the samples was conducted at the Whistler Carbohydrate

Table 23. Carbohydrate-COD correlation data.

Hydrolysis Conditions	COD (mg/L)	NOD (mg/L)	CCOD (mg/L)	Carb. (mg/L)	CarbOD (mg/L)	CarbOD/CCOD (%)
30C, 2%, 2.0 hr	665	24	641	194	209	32.6
30C, 2%, 6.0 hr	1457	131	1326	585	632	47.7
30C, 2%, 14.0 hr	2348	456	1892	1434	1549	81.9
30C, 2%, 22.0 hr	3557	655	2902	2137	2308	79.5
30C, 6%, 2.0 hr	1397	121	1276	929	1003	78.6
30C, 6%, 6.0 hr	3773	480	3293	2384	2575	78.2
30C, 6%, 14.0 hr	5534	829	4705	3560	3845	81.7
30C, 6%, 22.0 hr	5772	880	4892	3200	3456	70.6
30C, 10%, 2.0 hr	2300	235	2065	1219	1317	63.8
30C, 10%, 6.0 hr	4669	675	3994	2987	3226	80.8
30C, 10%, 14.0 hr	5605	866	4739	3321	3587	75.7
30C, 10%, 22.0 hr	5652	898	4754	2611	2820	59.3
70C, 2%, 1.0 hr	4885	997	3888	2848	3076	79.1
70C, 2%, 2.5 hr	5215	1199	4016	3283	3546	88.3
70C, 2%, 4.0 hr	5476	1199	4277	3404	3676	85.9
70C, 2%, 7.0 hr	5173	1199	3974	3912	4225	100
70C, 6%, 1.0 hr	5794	1199	4595	3819	4125	89.8
70C, 6%, 4.0 hr	5950	1085	4865	3107	3356	69.0
70C, 6%, 7.0 hr	5006	1119	3887	2722	2940	75.6
70C, 10%, 2.5 hr	5045	1033	4012	3529	3811	95.0
70C, 10%, 4.0 hr	5251	1141	4110	3000	3240	78.8
70C, 10%, 7.0 hr	4714	1050	3664	2579	2785	76.0

Research Center at Purdue University. Initial analysis of the samples was completed using the phenol-sulfuric carbohydrate test. Results from these tests were in agreement with those results presented in Figure 37, including the observed discoloration of the samples following the phenol-sulfuric test procedure. Based on these results, additional testing on the two samples which had undergone the "harsher" hydrolysis was performed. High pressure liquid chromatography (HPLC) was employed to determine both the quantitative and qualitative carbohydrate values, as well as to look for other possible by-products including aldehydes, ketones, and sugars containing nitrogen groups.

The results of the HPLC analysis of the samples showed no evidence of monosaccharides or the di- through hexa-polysaccharides. In addition, no longer chain polymeric compounds were observed to precipitate when the samples were treated with methyl alcohol. Finally, analysis for nitrated sugars, aldehydes, and ketones also failed to show positive results. Possible interpretations of these findings are: that the soluble hydrolysate, following the "harsh" level of hydrolysis, was composed of low molecular weight carbon species (i.e., at 2-4 carbons in length), which were no longer made up of the simple sugars and their immediate derivatives; or, that the soluble hydrolysate was composed of low molecular weight carbon species (i.e., at 6 carbons in length) similar to the simple sugars, but containing functional groups that interfered with the HPLC analysis.

Cyanide Analysis Results

Cyanide analysis was performed on the hydrolysate to help determine its significance as a treatment by-product. Previous investigations and conversations with plant personnel had indicated that hydrolysate cyanide values ranging from approximately 0.01 to 100 mg/L could be expected depending on the hydrolysis conditions. While the lower values were of little concern, cyanide values in the multiple parts per million range would have posed a serious problem to the final utility of the process.

Cyanide analysis was performed using HACH cyanide powder pillows following the procedures set forth in Section 3.1.2.2. These analyses were carried out on hydrolysate samples following both 30 and 70 °C hydrolysis of the munitions-grade NC, in caustic solutions ranging from 2 to 10 percent by weight.

Figure 38 (a) and (b) shows the results of these tests. These results were encouraging in that the cyanide values obtained did not approach the higher values expected. Analysis performed on the 30 °C hydrolysate resulted in cyanide values ranging from 0.10 mg/L after 2 hours of hydrolysis, to 1.20 mg/L

following 24 hours of treatment. While under these conditions, cyanide formation appeared to be time dependent, no correlation could be made between the caustic concentration and cyanide formation.

Hydrolysis at 70 °C resulted in cyanide concentrations ranging from 0.77 to 2.16 mg/L. These values appeared to be both time dependent and dependent on the caustic concentration used in the hydrolysis. As would be expected, the rate of cyanide formation was much faster at elevated temperatures. While these results do indicate a trend toward higher cyanide concentrations with the increasing severity of the hydrolysis, the values are sufficiently low as not to pose a problem during subsequent biological treatment of the hydrolysate.

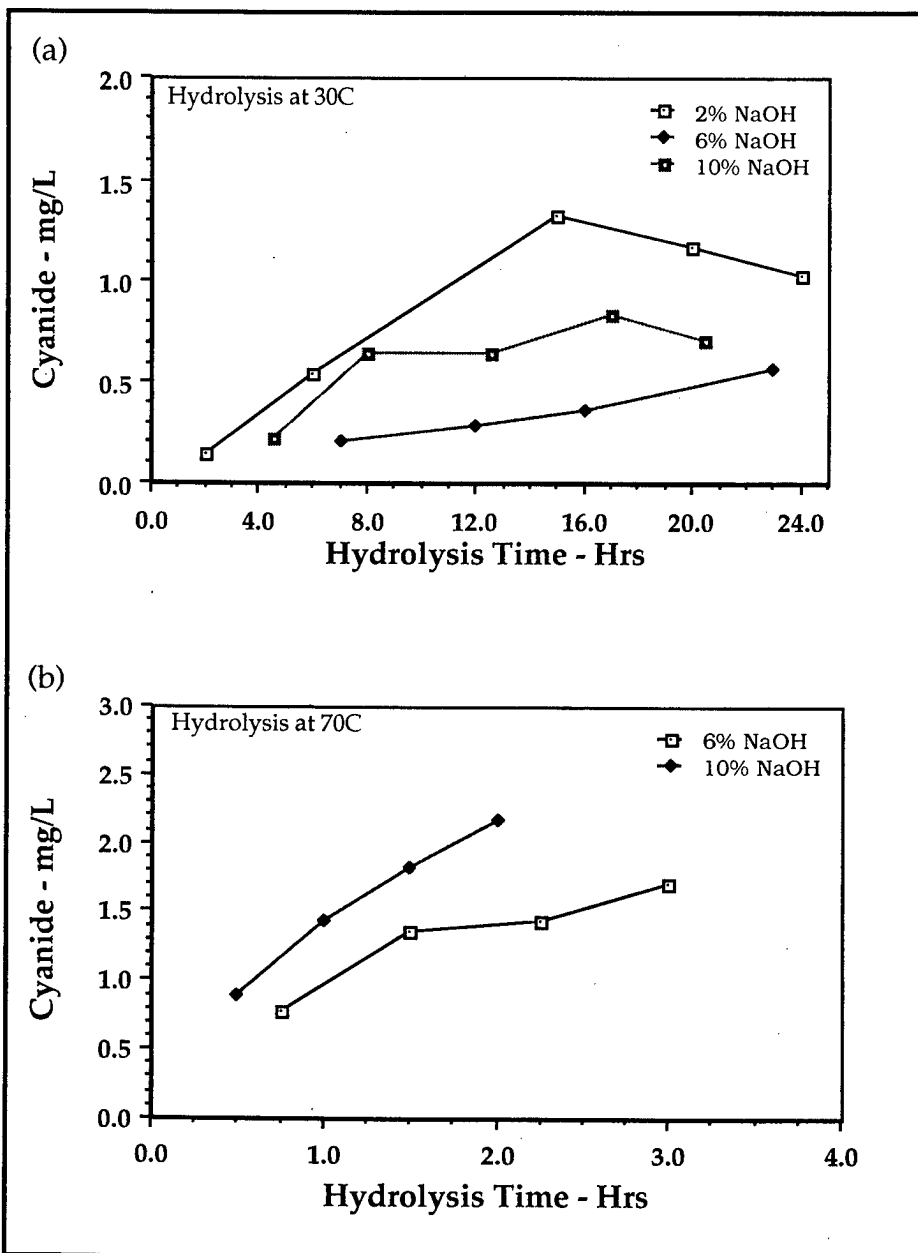

Figure 38. Hydrolysate cyanide analysis results following hydrolysis at (a) 30°C and (b) 70°C.

Gas Chromatography/Mass Spectrometry Results

Gas chromatography/mass spectrometry was performed to help qualify and quantify the volatile organic compounds in the hydrolysate. The resulting chromatograms, however, showed only those peaks associated with the solvent (methylene chloride) used in the extraction procedure, and a few trace hydrocarbons. The latter, probably resulting from either contamination of the samples during the extraction procedure or during the actual NC manufacturing process. The lack of significant peaks obtained on analysis of these samples provided a good indication that the hydrolysate did not contain substantial quantities of VOCs.

Biological Treatment Studies

Biological treatment studies were conducted in parallel with the chemical characterization studies just discussed. The purpose of these studies was to determine at what level of hydrolysis the hydrolysate became amenable to biological treatment, and to determine what factors influenced this amenability. The biological treatment studies consisted of: respirometric BOD tests, Microtox toxicity tests, and nitrification/denitrification/treatability tests on a pilot scale.

Biochemical Oxygen Demand Results

Respirometric biochemical oxygen demand tests were conducted following the protocol set forth in Chapter 3, "Post-Hydrolysis Biodegradation Studies" (p 54) using two four-cell N-CON respirometers connected in series. These tests were conducted on aliquots of the same munitions-grade NC hydrolysate samples used in the COD tests discussed in the preceding section. Figure 39(a) through 39(c) show the results of these studies.

In these figures, the BOD₅ values, in mg/L, are plotted versus the hydrolysis time in hours, for hydrolysis temperatures of: (a) 30 °C, (b) 50 °C, and (c) 70 °C. It is apparent from these figures that the biodegradability of the 30 °C hydrolysate samples was significantly lower than that of the 50 or 70 °C samples. In addition, it appears that, while the biodegradability of the samples increased with hydrolysis time within each temperature group, little change in biodegradability was observed between samples digested at the three caustic doses.

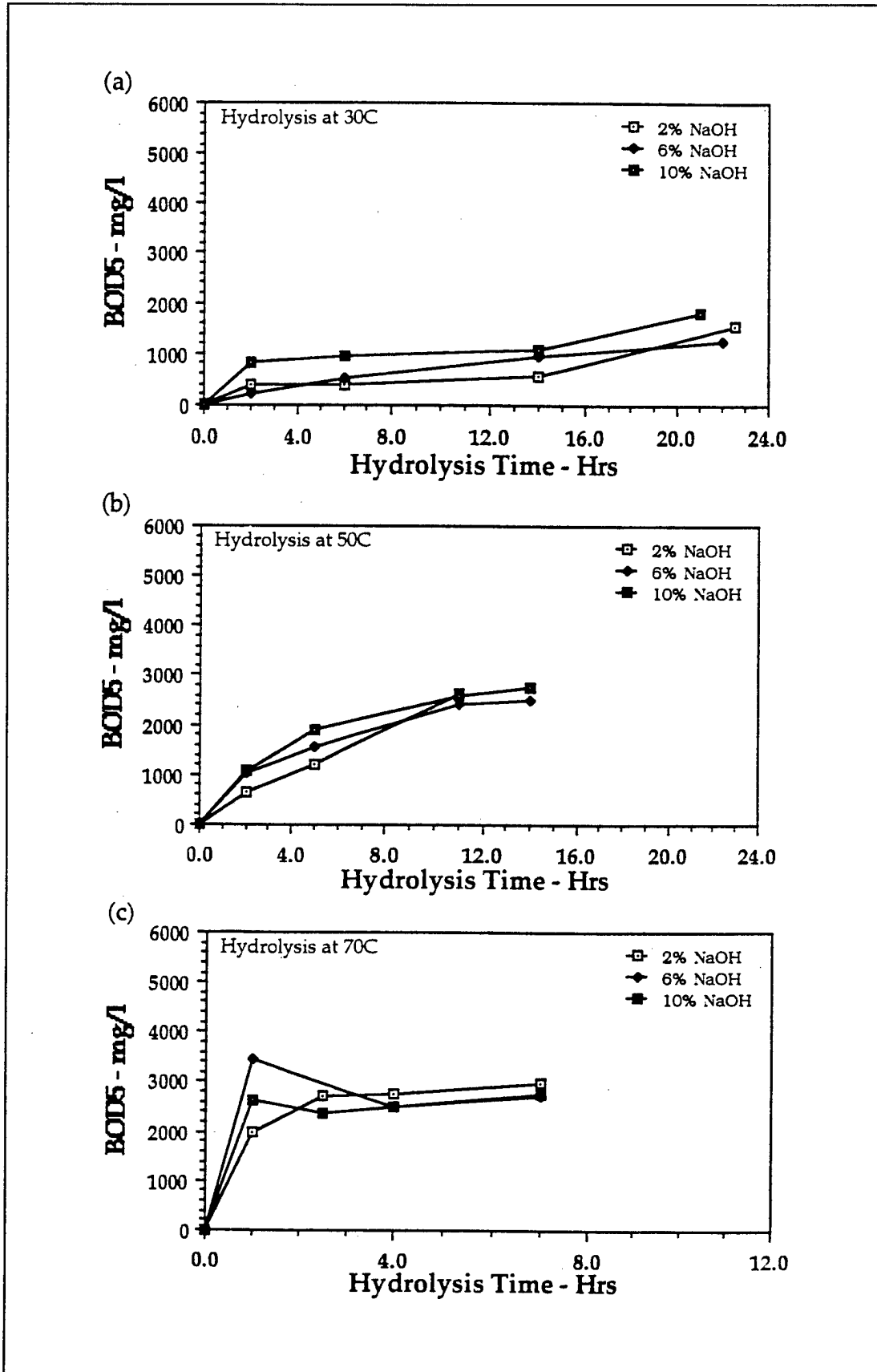

Figure 39. Hydrolysate BOD5 following hydrolysis at (a) 30°C, (b) 50°C, and (c) 70°C.

For those samples hydrolyzed at 30 °C, a maximum BOD5 value of 1,823 mg/L was attained, while those samples hydrolyzed at 50 and 70 °C achieved maximum BOD5 values of 2,784 and 3,466 mg/L, respectively. The soluble COD values corresponding to these maximum BOD5 values were 5652, 5433, and 5,794 mg/L, respectively. In comparison, the results of BOD5 tests using a glucose concentration of 1,538 mg/L, resulted in a BOD5 value of 996 mg/L and a COD value of 1551 mg/L. It is apparent that while the biodegradability of the hydrolysate did increase with the increasing severity of the alkaline hydrolysis process, in all cases there was still a nonbiodegradable or slowly biodegradable organic fraction associated with the hydrolysate.

BOD5/COD Ratios. While the BOD5 values by themselves are good indicators of the magnitude of the biochemical oxygen demand, and show the effect of the various parameters on this oxygen demand, the BOD5/COD ratio is often taken as a more representative indicator of apparent biodegradability. For this reason, the BOD5/COD ratios were determined.

Typical BOD5/COD ratios for untreated domestic wastes vary from 0.4 to 0.8 (Tchobanoglous and Burton 1997). The BOD5/soluble COD ratio for the 1,538 mg/L glucose control was likewise determined to be 0.64. While the NC hydrolysate bears little resemblance to domestic wastewater, nor would it be expected to be as readily biodegradable as glucose. Comparison of the hydrolysate BOD5/COD ratios with these typical values provided a means of determining the relative biodegradability of the hydrolysate samples.

Because the samples contained large quantities of reduced nitrogen, i.e., in the form of nitrite, it was necessary to subtract the oxygen demand associated with this nitrogen from the total oxygen demand of the samples before comparison. It was assumed that the entire nitrite content would have been oxidized during the COD test, hence the total oxygen demand associated with the nitrite was subtracted from these values. However, it was unlikely that the entire quantity of nitrite was oxidized during the BOD5 tests because of the unknown health of the nitrifier population. Because nitrite and nitrate analyses were not conducted in association with the BOD5 tests, it was assumed that only 50 percent of the available nitrite was biologically oxidized during the test. Thus, only 50 percent of the available NOD was subtracted from the BOD values to obtain the CBOD of the samples.

The BOD5/COD ratios determined in this manner are presented in Table 24. It is apparent from this table that the biodegradability of the hydrolysate samples increased as the severity of the hydrolysis conditions increased. In addition, it appears that this biodegradability was strongly dependent on the hydrolysis

Table 24. BOD5/COD ratios as a function of the initial hydrolysis conditions.

Hydrolysis Conditions	COD (mg/L)	BOD5 (mg/L)	NOD (mg/L)	BOD5/COD Ratio	CBOD/CCOD Ratio
30C, 2%, 2.0 hr	665	367	24	0.55	0.55
30C, 2%, 6.0 hr	1457	405	131	0.28	0.26
30C, 2%, 14.0 hr	2348	545	456	0.23	0.17
30C, 2%, 22.0 hr	3557	1553	655	0.44	0.42
30C, 6%, 2.0 hr	1397	195	121	0.14	0.11
30C, 6%, 6.0 hr	3773	506	480	0.13	0.08
30C, 6%, 14.0 hr	5534	961	829	0.17	0.11
30C, 6%, 22.0 hr	5772	1257	880	0.22	0.17
30C, 10%, 2.0 hr	2300	811	235	0.35	0.34
30C, 10%, 6.0 hr	4669	928	675	0.20	0.15
30C, 10%, 14.0 hr	5605	1072	866	0.19	0.13
30C, 10%, 22.0 hr	5652	1823	898	0.32	0.29
50C, 2%, 2.0 hr	1899	631	610	0.33	0.25
50C, 2%, 5.0 hr	4154	1187	914	0.29	0.23
50C, 2%, 11.0 hr	5877	2638	1168	0.45	0.44
50C, 6%, 2.0 hr	4882	1015	977	0.21	0.13
50C, 6%, 5.0 hr	5564	1536	1182	0.28	0.22
50C, 6%, 11.0 hr	5677	2431	1027	0.43	0.41
50C, 6%, 14.0 hr	5481	2514	959	0.46	0.45
50C, 10%, 2.0 hr	5589	1089	907	0.19	0.14
50C, 10%, 5.0 hr	5563	1911	947	0.34	0.31
50C, 10%, 11.0 hr	5568	2580	967	0.46	0.46
50C, 10%, 14.0 hr	5433	2784	957	0.51	0.52
70C, 2%, 1.0 hr	4885	1964	997	0.40	0.38
70C, 2%, 2.5 hr	5215	2713	1199	0.52	0.53
70C, 2%, 4.0 hr	5476	2783	1199	0.51	0.51
70C, 2%, 7.0 hr	5173	2999	1199	0.58	0.60
70C, 6%, 1.0 hr	5794	3466	1199	0.60	0.62
70C, 6%, 4.0 hr	5950	2491	1085	0.42	0.40
70C, 6%, 7.0 hr	5006	2724	1119	0.54	0.56
70C, 10%, 2.5 hr	5045	2356	1033	0.47	0.46
70C, 10%, 4.0 hr	5251	2514	1141	0.48	0.47
70C, 10%, 7.0 hr	4714	2751	1050	0.58	0.61

time and temperature, and not as dependent on the caustic concentration used in the hydrolysis.

Samples prepared under the low temperature hydrolysis conditions remained substantially less biodegradable than those prepared at the higher temperatures, regardless of the caustic dose employed or the reaction time. Hydrolysis at slightly elevated temperatures of 50 to 70 °C resulted in much improved amenability to subsequent biodegradation, with BOD5/COD ratios well within the range typically observed for domestic wastewaters and nearly equal to that observed for the glucose control. In addition, this improved

biodegradability at the elevated temperatures was achieved using low caustic concentrations and short reaction times. This finding was significant from the standpoint of the overall practicality of the combined chemical/biological process.

Oxygen Demand of Removed and Residual Organics. Another important indicator of the inherent biodegradability of the hydrolysate was the observed removal of organic carbon from the samples during biological treatment. These values, in combination with the BOD₅, COD, and NOD values already discussed, were used to determine the average oxidation state of the organic species removed from the hydrolysate on biological treatment, and the average oxidation state of those organics remaining in the hydrolysate following biodegradation.

To illustrate the interdependence of these various values, the results of an analysis conducted on a 70 °C, 2 percent NaOH, 2.5 hour digested hydrolysate are presented in the following figures. Figure 40 shows the total oxygen demand for this hydrolysate sample, as it decreased during the 120-hr respirometric BOD test.

In this figure, the total oxygen demand available at the beginning of the 5-day BOD test is indicated by the COD line. From this total oxygen demand the estimated NOD was subtracted to give the oxygen demand of carbonaceous material. As in the preceding section, it was assumed that only 50 percent of the available nitrite was oxidized to nitrate by the *Nitrobacter* bacteria. Thus, only 50 percent of the available NOD was subtracted. The residual oxygen demand, not accounted for by the combined NOD-CBOD value, represented the remaining oxygen demand of all organic species in the hydrolysate that were still not fully oxidized.

Figure 41 shows the total organic carbon results for this same hydrolysate sample. Because organic carbon values were only measured at the beginning and end of the 5-day test, the intermediate values were estimated for visual purposes only.

The total organic carbon removed from the samples during biological treatment was determined by subtracting the final organic carbon concentrations from the initial organic carbon values. Both of these values were also corrected for the initial and final organic carbon of the seed blank. The organic carbon not removed by the biological treatment is referred to as the residual organic carbon (ROD).

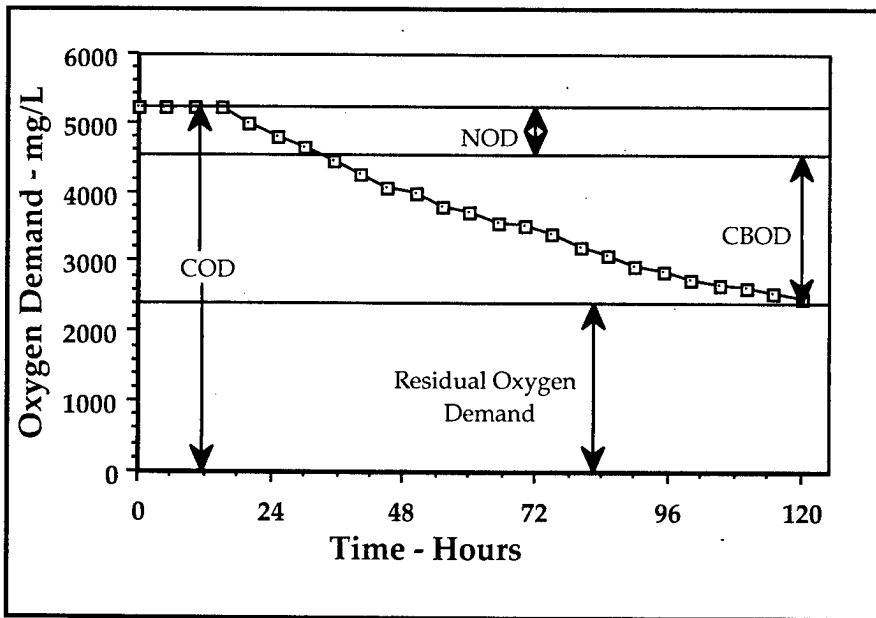

Figure 40. Decrease in total oxygen demand during a 120-hr BOD run for a hydrolysate digested at 70°C in 2% NaOH for 2.5 hours.

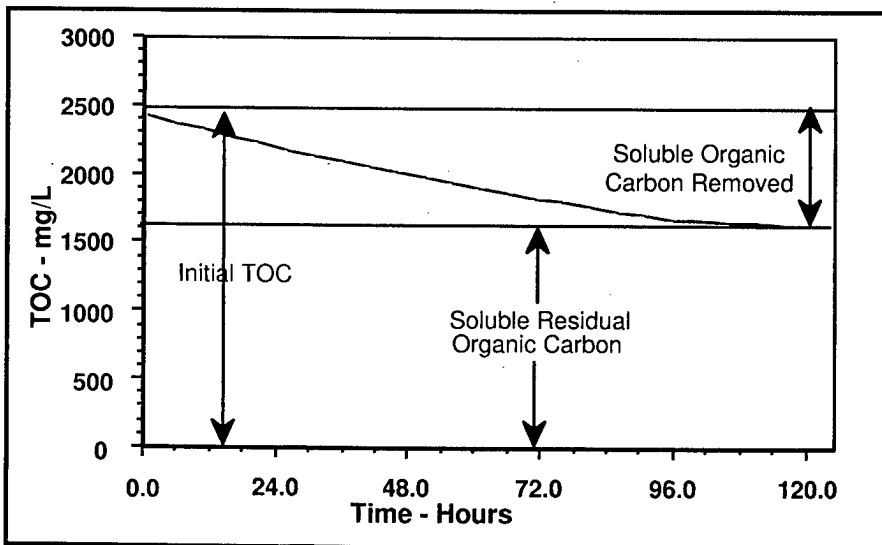

Figure 41. Decrease in total organic carbon during a 120-hr BOD run for a hydrolysate digested at 70°C in 2% NaOH for 2.5 hours.

As stated earlier, the carbon present in the NC structure is at a zero oxidation state. For this carbon to be removed from the hydrolysate it must be either oxidized all the way to carbon dioxide (+4 oxidation state) or assimilated into new cells. Oxidation would create a demand of 2.667 mg O₂/mg C oxidized. As the oxidation state of the initial carbon increases, the corresponding oxygen demand decreases. Thus, if all the carbon species removed from the hydrolysate through biological treatment were oxidized from C₀ to C₊₄, a CBOD/TOCREM ratio of 2.667 would be observed. Figure 42 shows the calculated CBOD/TOCREM ratios, covering hydrolysis conditions ranging from the least severe to most severe, are presented in. Likewise, Figure 43 shows the

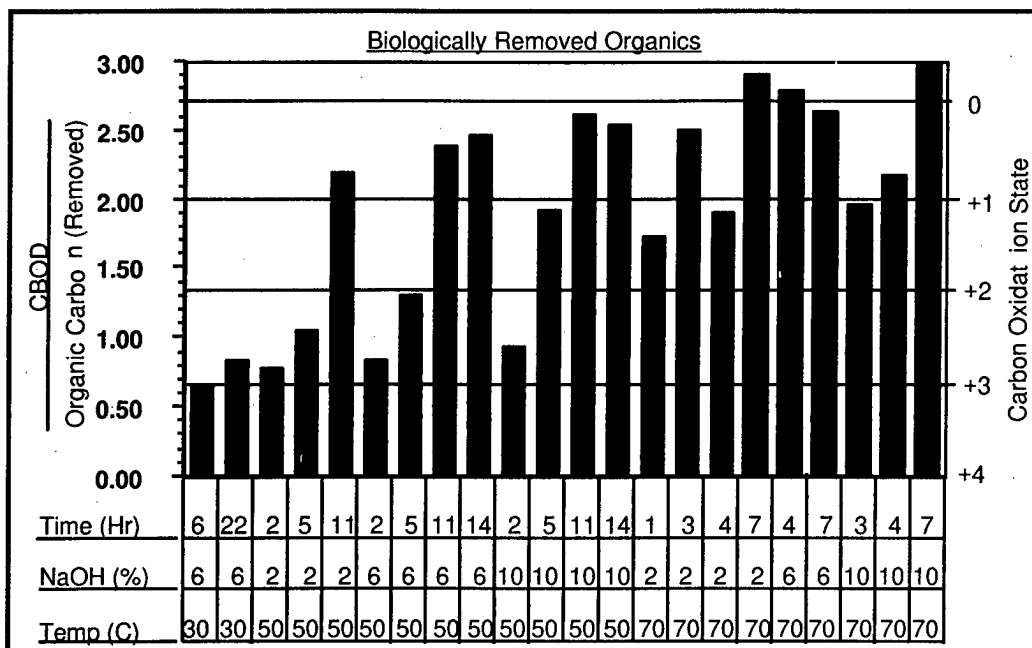

Figure 42. CBOD/TOC (removed) ratios versus the hydrolysis conditions.

ROD/TOCRES ratios. In this figure, the average residual oxygen demands in mg O₂/mg of residual carbon are plotted for the various hydrolysis conditions.

It can be concluded that as the severity of the hydrolysis conditions increase, from left to right, the average oxidation state of the organic species removed from solution decreases (CBOD/TOCREM ratio increases). Under the least severe conditions tested during the biological treatment phase (i.e., 6 percent NaOH, for 6 hours and 30 °C) a significant fraction of the soluble organics maintained a high degree of polymerization and thus their original zero oxidation state. These large organics remained substantially nonbiodegradable and were not removed from solution. The remaining fraction, consisting of low molecular weight, slightly oxidized organics, was only nominally biodegradable.

Under the most severe hydrolysis conditions (i.e., 70 °C for 7 hours in 10 percent caustic), the CBOD/TOCREM ratio was approximately 2.7. This indicated that, under these conditions, hydrolysis was sufficiently rapid that a large fraction of the organics underwent depolymerization without significant deterioration of the individual monomers. The resulting low molecular weight, fully reduced fraction exhibited significant biodegradability and was readily removed. The other fraction, under these conditions, was composed of by-products from the secondary redox reactions. These organics were highly oxidized and substantially nonbiodegradable.

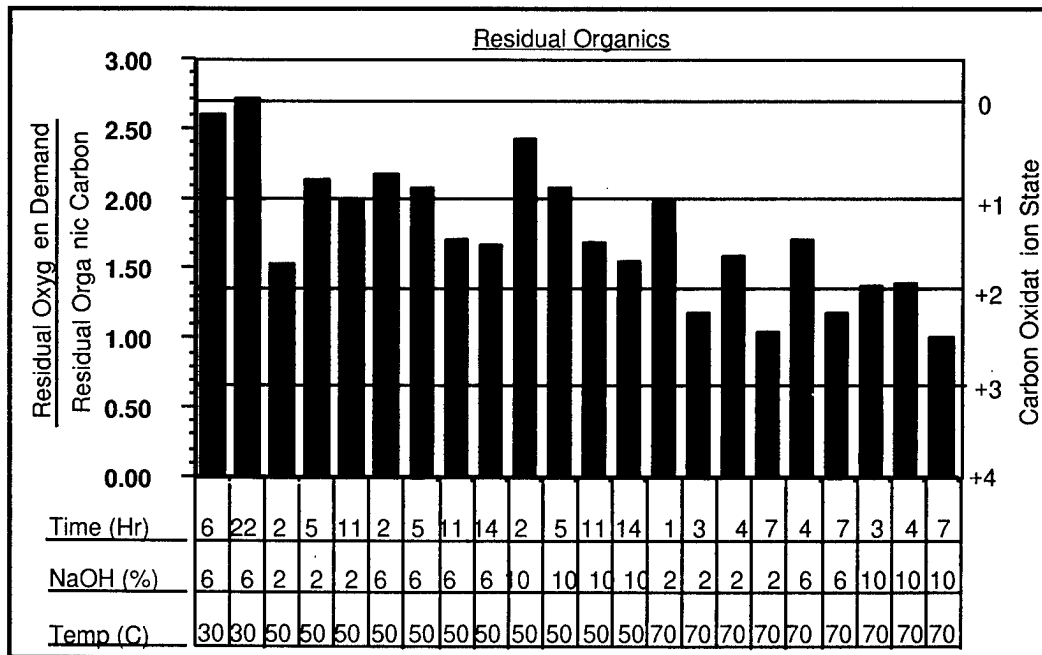

Figure 43. ROD/TOC (residual) ratios versus the hydrolysis conditions.

Similarly, Figure 43 shows the residual oxygen demand (ROD)/residual organic carbon ratios. It is apparent from this figure that the organic species not completely removed via biodegradation were partially oxidized.

The results shown in this figure support those presented in Figure 42. The organic fraction remaining in the hydrolysate following biological treatment of the "soft" hydrolysis samples (i.e., 6 percent NaOH, for 6 hours and 30 °C) consisted of highly polymerized, reduced, nonbiodegradable organics. At the other extreme, the organics remaining following "hard" hydrolysis (i.e., 10 percent NaOH, for 7 hours and 70 °C) consisted of low molecular weight species that had undergone partial oxidation to non-biodegradable compounds.

It is important to note that Figures 42 and 43 were developed without taking cell growth into consideration. A portion of the available organic carbon would have been used for the synthesis of new cells, and thus not oxidized. If cell growth had been quantified during these tests, the carbon removed from the system via assimilation could have been subtracted from the TOCREM value. In this manner, only that carbon biologically oxidized would be included in the TOCREM value, thus lowering the average oxidation state of the post-biodegradation organics.

Microtox Toxicity Analysis

Toxicity screening tests were performed on the hydrolysate using the Microtox test procedures. These tests were conducted to determine if the hydrolysate

would have an inhibitive effect on subsequent biological treatment, and to determine if there was a correlation between toxicity and the severity of the hydrolysis process. Figure 44 shows the results of the Microtox toxicity tests.

The hydrolysis conditions tested, ranged from a minimum hydrolysis (6 percent caustic for 6 hours at 30 °C) to the most severe hydrolysis conditions (10 percent caustic for 4 hours at 70 °C). The toxicity results are presented as toxicity units (TUs). Toxicity units were obtained by dividing 100 by the EC50s for the various samples.

It is evident from Figure 44 that the toxicity of the samples decreased as the severity of the hydrolysis conditions increased. Thus, the greatest toxicity was observed after the low temperature, 6 percent caustic, 6 hour digestion. Two samples of the 50 °C hydrolysate deviated from this observed trend. This deviation was thought to have resulted from the improper neutralization of the samples before testing.

Some toxic materials affect the Microtox organisms virtually instantaneously, while others complete their effect in as little as 5 minutes. Still others, notably bivalent metals, require approximately 15 minutes to complete their effect (Microbics Corporation 1992). To take into account this variability in the observed toxicity with time, the toxicity of the samples was recorded at two different exposure times, 10 and 20 minutes. Over the entire range of hydrolysis conditions, 20-minute exposure to the hydrolysate caused an increase in toxicity to the microorganisms.

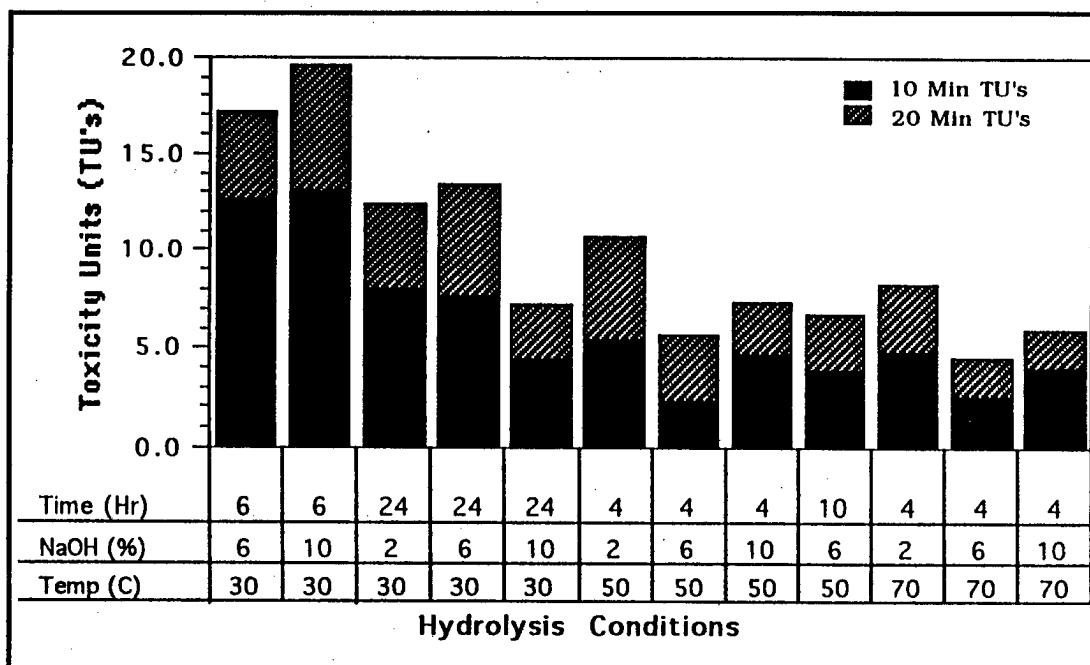

Figure 44. Microtox toxicity test results.

Any toxic effect to subsequent biological treatment could be eliminated by diluting the given hydrolysate sample so that its concentration in the biological reactor was less than its corresponding EC50. For these samples, the greatest required dilution would thus be seventeen fold for the samples digested under the least severe hydrolysis conditions tested during the biodegradation studies. Such a dilution factor would be easily obtained on full-scale implementation of the process.

Nitrification/Denitrification/Treatability Studies

The biological treatability aspect of the overall alkaline hydrolysis/biological treatment process was approached from the standpoint of determining at what point during the hydrolysis reaction the waste became substantially biodegradable. Optimization of the biological treatment phase in terms of the solids and hydraulic retention times and recycle rates was not addressed. It is, therefore, important to point out the preliminary nature of this phase of the research.

Two separate treatability tests were conducted during this research. The intent of these studies was to determine the effectiveness of the biological processes in treating the unique waste stream resulting from the hydrolysis of the NC. The high nitrite and nitrate concentrations found in the hydrolysate feed solutions were of particular concern. Thus, any successful biological process would have to encompass both nitrification and denitrification, as well as COD removal. In addition, the high TDS concentration resulting from the hydrolysis and neutralization procedures was also of concern relative to subsequent biological treatment.

A continuous flow, stirred reactor was used. This reactor was maintained at an SRT of 10 days and an HRT of 5 days. Because the mixed liquor was continuously aerated, denitrification was inhibited. The CFSTR was maintained for 25 days (2.5 SRTs) during which time influent and effluent COD, TOC, nitrite, nitrate, TSS, and VSS were continuously monitored. Digested NC feed solutions for both studies were prepared as described in Chapter 3, "Post Hydrolysis Biodegradation Study," (p 54).

Figure 45 shows the nitrite removal results for the CFSTR study. Because ammonia concentrations in the hydrolysate feed were found to be insignificant, Figure 45 actually represents the total biological nitrification occurring in the pilot reactor. The fact that nitrification began immediately, was evidence for the presence of an established nitrifier population, or at least *Nitrobacter* population, in the reactor as well as the seed culture used to start the reactor.

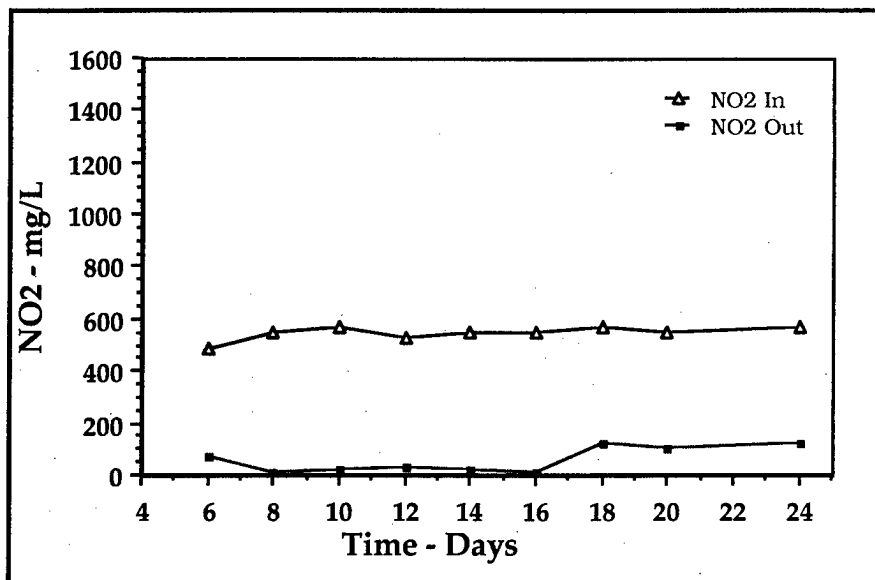

Figure 45. CFSTR influent and effluent nitrite concentration versus time.

At steady state operation, ~2.5 SRTs, nitrite nitrogen removal through nitrification reached approximately 78 percent removal efficiency.

Nitrate, which was oxidized from nitrite during the nitrification phase, plus the nitrate in the feed solution, represented the total nitrate-nitrogen in the reactor. While the reactor was continuously aerated during this study, thus inhibiting denitrification, a mass balance on nitrate showed that limited denitrification was occurring (Table 25). Additional evidence for this denitrification was supported by the appearance of gas bubbles and floating sludge in the clarifier of the reactor. At steady state, this limited nitrate removal, however, represented only 2 percent of the nitrate present in the reactor. A mass balance on soluble carbon following the hydrolysis of a 10,000 mg/L munitions-grade NC sample showed carbon losses as carbon dioxide to be insignificant under the most severe hydrolysis conditions tested (Table 26).

Had this study incorporated an anoxic period, thus allowing for denitrification, the theoretical nitrate removal, based on the available BOD, would have been approximately 160 mg/L or a 21 percent removal efficiency. This would indicate that, for full denitrification of this waste, an additional substrate would have to be provided. This additional substrate could be in the form of added methanol or an additional wastewater stream high in BOD. Figure 46 shows influent and effluent nitrate concentrations for the CFSTR study.

Figures 47 and 48, respectively, show TOC and COD removal results. Analysis of these results showed that nitrite oxidation accounted for approximately 78 percent of the observed COD reduction while carbon oxidation accounted for 22

Table 25. Hydrolysate nitrogen mass balance.

	30°C, 6%, 6 hr.	70°C, 10%, 7 hr.
Particulate - N (mg/L)	778	0.0
Soluble - N (mg/L)	537	1,189
Soluble NO ₂ -N (mg/L)	~420	~919
Soluble NO ₃ -N (mg/L)	~117	~270
Ammonia-N (mg/L)	<0.5	<1.0
Cyanide-N (mg/L)	<0.2	<2.0

Table 26. Hydrolysate carbon mass balance.

	30°C, 6%, 6 hr.	70°C, 10%, 7 hr.
Particulate - C (mg/L)	819	0.0
Soluble - C (mg/L)	1,581	2,400.0
CO ₂ - C (mg/L)	0.0	0.0
Carbon as Carbo. - C (mg/L)	954	1,032
Remaining Carbon (mg/L)	627	1,368

percent of the COD reduction. The overall TOC removal efficiency for this reactor setup was determined to be only 23 percent at steady state, while the COD removal efficiency was 43 percent.

Nitrification is typically harder to achieve than TOC removal in treatment systems. The treatability results are, therefore, encouraging from the standpoint of the observed nitrification.

TOC removal appeared to be much less effective. Based on the CFSTR performance, it would appear that the organic fraction of the hydrolysate was still resistant to biodegradation (i.e., 23 percent TOC removal). In comparison, TOC removal in the batch respirometric tests ranged from approximately 30 to 45 percent. This discrepancy could be due, in part, to the acclimation period of the bacterial culture to the hydrolysate in each of these tests. The decrease in the reactor VSS concentration with time provided additional evidence for the resistance of these organics. Figure 49 shows the reactor MLVSS concentration with time. It is questionable, based on this figure, whether or not the hydrolysate alone was an adequate substrate to prevent the failure of the reactor.

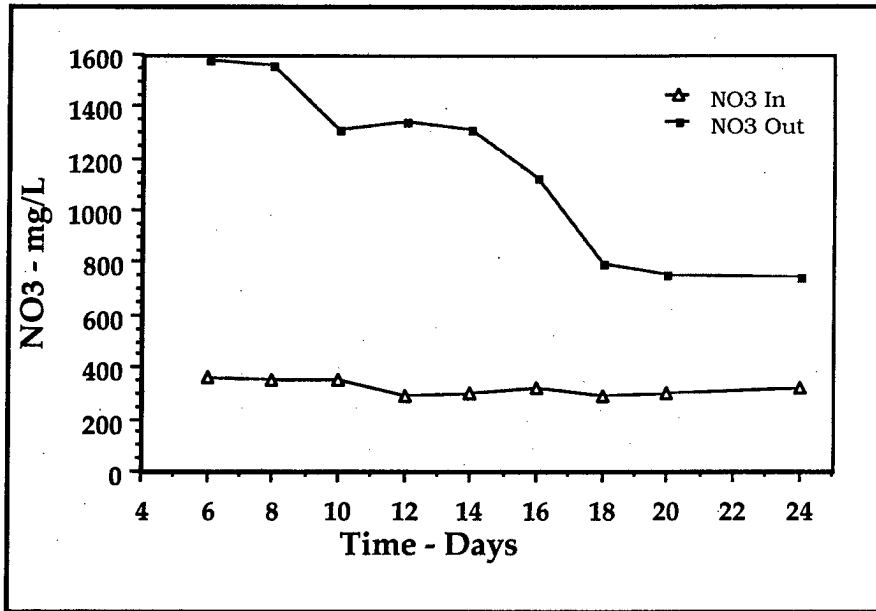

Figure 46. CFSTR influent and effluent nitrate concentration versus time.

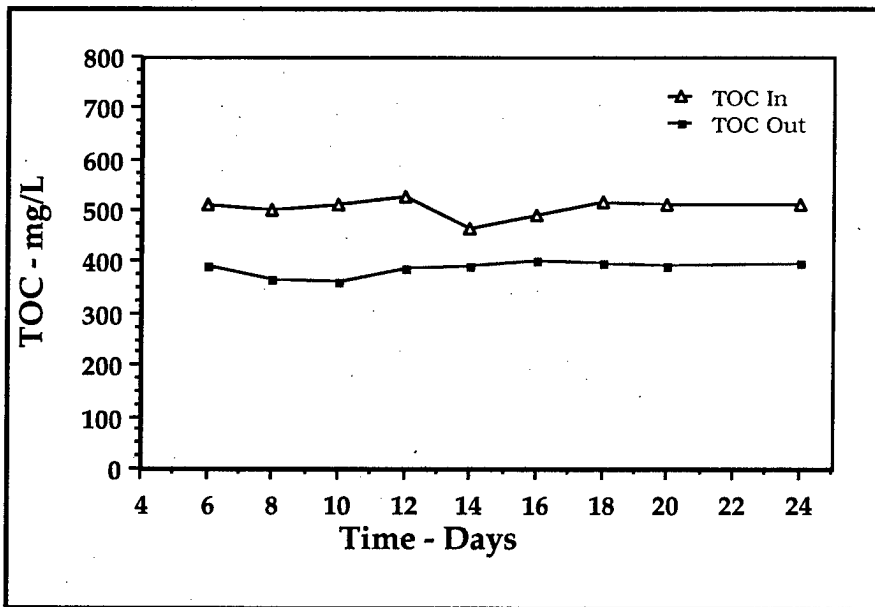

Figure 47. CFSTR influent and effluent TOC concentration versus time.

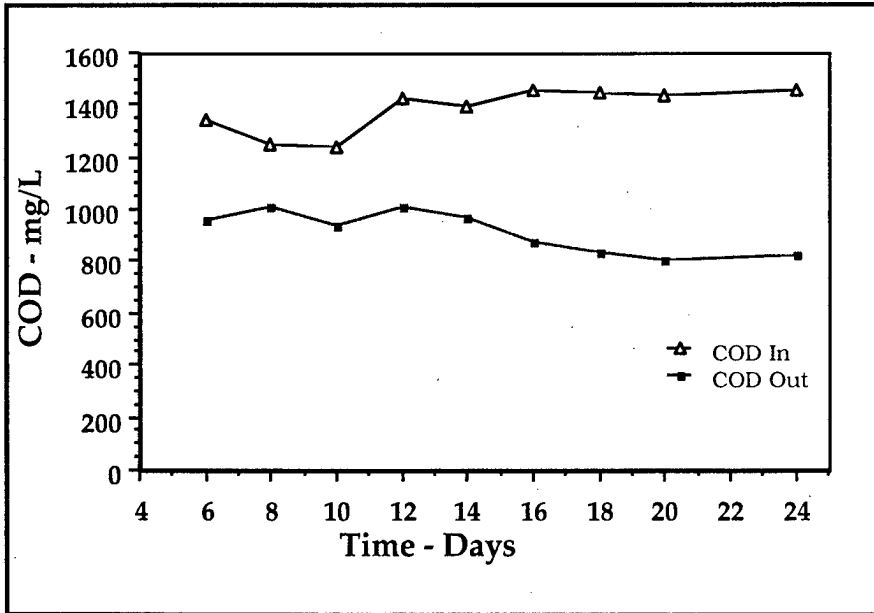

Figure 48. CFSTR influent and effluent COD concentration versus time.

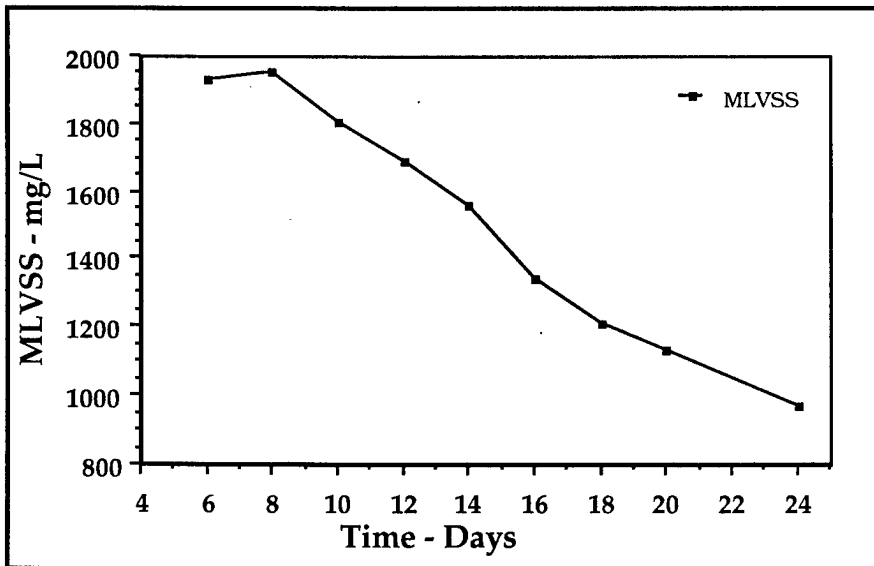

Figure 49. Treatability reactor MLVSS versus time.

5 Conceptual Design

Conceptual Design Development and Discussion

The alkaline hydrolysis of NC manufacturing residuals has been shown to be an effective and predictable method of removing these materials from the process wastewater stream by rendering them biodegradable. While numerous possible design variations exist for the full scale implementation of such a process, any design must include:

- separation/concentration of the NC "fines" from the process wastewater
- alkaline hydrolysis of the NC slurry
- neutralization of the hydrolysate using recovered acid
- biological treatment of the resulting high strength liquor.

Possible variations in the process design include: the type of concentration/separation technology employed, batch or continuous flow alkaline treatment, the hydrolysis conditions (i.e., time, temperature, and caustic dose employed), possible heat recovery from the hydrolysis and/or neutralization step, and the type of biological treatment process employed. Figure 50 shows one possible treatment scenario.

The flow diagram presented in Figure 50 represents a continuous flow alkaline hydrolysis treatment process followed by aerobic biological treatment. Note that this schematic represents only one possible treatment train. Additional work will be required to determine the ideal treatment system configuration to efficiently and economically treat the NC fines.

In the first step of this conceptual treatment process, a concentrated NC slurry and sodium hydroxide are metered, separately, into a continuous flow, stirred reactor. The reactor is maintained at the desired reaction temperature via natural gas heat. Influent and effluent flow rates are monitored to ensure that the desired residence time is maintained. The effluent from this reactor is pumped to a neutralization reactor where the high pH hydrolysate is neutralized using sulfuric acid recovered from the boiling tub pits or other plant operations. Finally, the neutralized hydrolysate, containing high nitrite, nitrate,

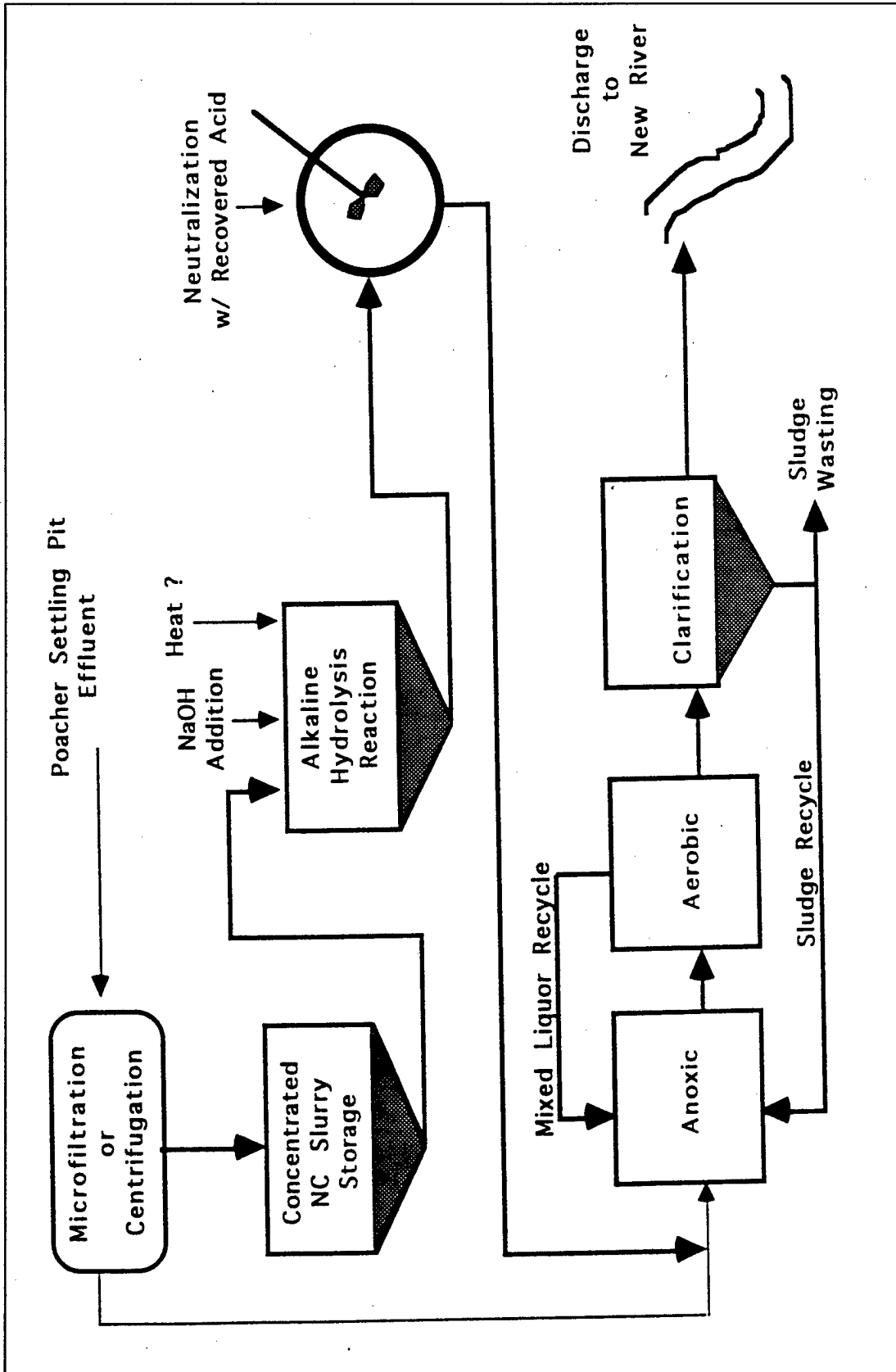

Figure 50. Flow diagram of alkaline hydrolysis/biodegradation process with denitrification.

COD, TOC, BOD, and TDS concentrations, is pumped to a biological treatment system employing both nitrification and denitrification.

While not shown in this design, heat recovery could also be incorporated into the treatment process to take advantage of heat generated from boiling tubs and poacher operations and additionally on neutralization of the hydrolysate. For heat recovery to be an economically viable option, the value of the recovered heat would have to offset the cost of the recovery equipment. However, because it is anticipated that low caustic concentrations and relatively dilute acid will be used in the hydrolysis and neutralization steps, it is unlikely that the heat generated on neutralization would be sufficient to warrant heat recovery.

This conceptual design was next combined with the results obtained from the hydrolysis kinetic studies and the hydrolysate chemical analyses to estimate the daily cost of the alkaline hydrolysis treatment and the expected load on the subsequent biological treatment system.

The first treatment scenario discussed is based on a constrained, nonlinear optimization of the solubilization equation presented in Chapter 4, "Results and Discussion," Predictive Model (p 76). In this scenario, the three variables used in the development of the model, time, temperature, and caustic dose, were all varied within certain constraints. The spreadsheet calculated the optimum solution to the solubilization equation based on a desired treatment performance of 100 percent solubilization of the concentrated munitions-grade NC slurry. The constraints were emplaced to ensure that the resulting solution fell within the range of values used in the development of the model. These constraints were hydrolysis temperatures ≤ 70 °C, and hydrolysis times ≤ 24 hours. The value of the third variable, caustic dose, was dictated by the other two. The concentration of the NC slurry was determined based on the expected performance of the separation/concentration steps of the treatment process applied to typical mass loadings observed in the poacher settling pit effluent.

The poacher settling pit effluent flow and NC concentration is contained in spreadsheet cells B6 through C10 (below). Values used in these cells were obtained from previous analysis of the RAAP wastewater treatment system (Balasco 1987; Kim and Park 1993).

	B	C
6	Q (MGD)	=0.9057
7	TSS (mg/l)	=143
8	TSS (lb/d)	=C6*8.34*C7
9	TDS (mg/l)	=C10/(8.34*C6)
10	TDS (lb/d)	=1000

Cells B18 through C22 represent the flow rate, TSS, and TDS values expected following concentration of the poacher settling pit effluent. The TSS mass loading following concentration was calculated based on a 70 percent solids removal efficiency on centrifugation (Balasco 1987).

	B	C
18	Q (MGD)	=C20/(8.34*C19)
19	TSS (mg/l)	=10000
20	TSS (lb/d)	=C8*0.7
21	TDS (mg/l)	=C22/(8.34*C18)
22	TDS (lb/d)	=7

Spreadsheet cells G8 through I19 contain the formulas and input values pertaining to the actual alkaline hydrolysis reaction. The hydrolysis conditions, temperature, NaOH concentration and reaction time, are input in cells I8-I10. Based on these input values, NaOH consumption (lb/d), heat requirement (BTU/d), the gas consumption (ft³/d), and the required reactor volume were calculated. Cells I17-I19 contain the estimated daily costs for caustic and natural gas.

	G	I
8	Temp. (C)	=109
9	NaOH (mg/l)	1000
10	HRT (hours)	12
11		
12	NaOH (lb/d)	=\$I\$9*8.34*\$C\$18
13	BTU/Day	=((\$C\$18*10 ⁶)*8.34*1*(((1.8*\$I\$8)+32)-70)
14	Gas (ft ³ /d)	=\$I\$13/1000
15	React Vol. (ft ³)	=((\$C\$18*10 ⁶)/24)*\$I\$10*0.13368
16		
17	NaOH (\$/d)	=((\$I\$12/2000)*2*250
18	Gas (\$/d)	=((\$I\$14/1000)*6)/0.7
19	Total (\$/d)	=I17+I18

The unit cost of NaOH used in the spreadsheet represents the most significant cost in the daily operation of the alkaline hydrolysis process. A unit cost of 250\$/ton of 50 percent NaOH was used in all such calculations (Nalco Chemical Co. 1994). The cost of natural gas, used in the design to heat the hydrolysis reactor, is significantly lower. A natural gas unit cost of 6\$/1000 ft³ was used in all calculations (Tehobamoglaus 1991).

Finally, the results of the alkaline hydrolysis reaction are contained in cells K15 through M22. Cell L16 contains the nitrocellulose solubilization equation presented in the Predictive Model in Chapter 4. However, due to the length of

the equation, it is just referenced to in the chart below. Cells L18 through L20 contain the COD, BOD, and TOC values for the hydrolysate. These equations were developed based on empirical relationships observed during the batch scale chemical and biological characterization of the munitions-grade NC hydrolysates. Because these values were empirically determined, they should be viewed as estimates only. Denitration results are contained in cells L21-L22. As with the solubilization reaction, the denitration equation is presented in the Predictive Model in Chapter 4. This equation actually predicts the nitrogen concentration remaining on the particulate NC. To estimate the nitrogen concentration in the hydrolysate it was thus necessary to subtract this value from the initial nitrogen concentration of the NC. The estimate of nitrite and nitrate in the hydrolysate were then determined based on the empirical relationship observed between the nitrite concentration and the combined nitrite/nitrate concentration. On statistical analysis, nitrite was shown to represent 75.9 percent of the combined nitrite/nitrate nitrogen.

	K	L	M
15		mg/l	lb/d
16	TSS	solubilization equation (Section 4.3.3)	=\$C\$18*8.34*\$L\$16
17	TDS	=(I\$9*(22.99/40))+C\$21	=\$C\$18*8.34*\$L\$17
18	COD	=0.59*(C\$19-\$L\$16)	=\$C\$18*8.34*\$L\$18
19	BOD	=\$L\$18*(0.1567+(0.005*I\$8))	=\$C\$18*8.34*\$L\$19
20	TOC	=0.24*(C\$19-\$L\$16)	=\$C\$18*8.34*\$L\$20
21	Nitrite	(denit. equation)*0.759*(46/14)	=\$C\$18*8.34*\$L\$21
22	Nitrate	=(L\$21/(0.759*(46/14)))*0.241*(62/14)	=\$C\$18*8.34*\$L\$22

Figure 51 shows the results of the first hydrolysis scenario. The optimum hydrolysis conditions, under the constraints mentioned previously, were determined to be a hydrolysis temperature of 60.3 °C, using a caustic concentration of 20,000 mg/L digested for 12.0 hours.

The optimization results were significant in that they showed the hydrolysis process to be effective and efficient using a relatively low caustic dose. Since the cost of the caustic is the most significant variable daily cost associated with the treatment process, this low caustic dose represents a significant cost savings over the elevated caustic levels suggested previously. In addition, by minimizing the caustic dose, the TDS impact on subsequent biodegradation and on the New River is kept to a minimum.

In comparison, Figure 52 shows the results of a low temperature, high caustic treatment scenario. While the same treatment objective of zero mg/L TSS was

achieved, the significant increase in the daily operating costs under these conditions, and the increased TDS values, would make this treatment option considerably less attractive.

The third scenario analyzed (Figure 53) was that using low temperature (30 °C), hydrolysis, and optimizing the other two parameters. The optimum caustic dose under these conditions would be 125,000 mg/L, while the hydrolysis time increased to 24 hours. The extremely high caustic dose required in this scenario would make it economically unfeasible, with a daily cost approximately five times that of the optimum solution. This caustic dose would also create a significant TDS load. Because TDS values in this range were not observed in any of the biodegradation or treatability studies, direct correlation of their effects cannot be made. However, it is believed that the significant dilution that would occur in the full scale biological treatment system would eliminate any inhibitory effects if they did exist.

The final scenario (Figure 54) represents low temperature and low caustic treatment conditions. Under these conditions, an exceedingly long reaction period of 260 hours would be required to achieve the same treatment objectives. This long reaction time and the associated reactor volume would make this treatment scenario uneconomical.

Conceptual Design Summary

In summary, it appears that low caustic concentrations (~20,000 mg/L) in combination with intermediate reaction temperatures (50-70 °C) will provide the most attractive treatment conditions, within the range of conditions studied, for the alkaline hydrolysis process. These treatment conditions not only result in the most efficient treatment in terms of reaction optimization, but also the most economical treatment. The resulting hydrolysate, while containing a high COD concentration, and high concentrations of TDS, nitrite and nitrate, should be substantially amenable to aerobic biological treatment. The organic load created by the hydrolysate on this biological treatment system, as well as the effect of the high TDS concentrations, should be minimized by the dilution factor of the full scale treatment system. When alkaline hydrolysis and biological treatment are used, the existing wastewater system with RBC can be modified to accommodate additional flow and to add anoxic system. Finally, the effluent from this treatment process should have no effect on the water quality of the New River based on the apparent treatability of the waste and the dilution factor of the river.

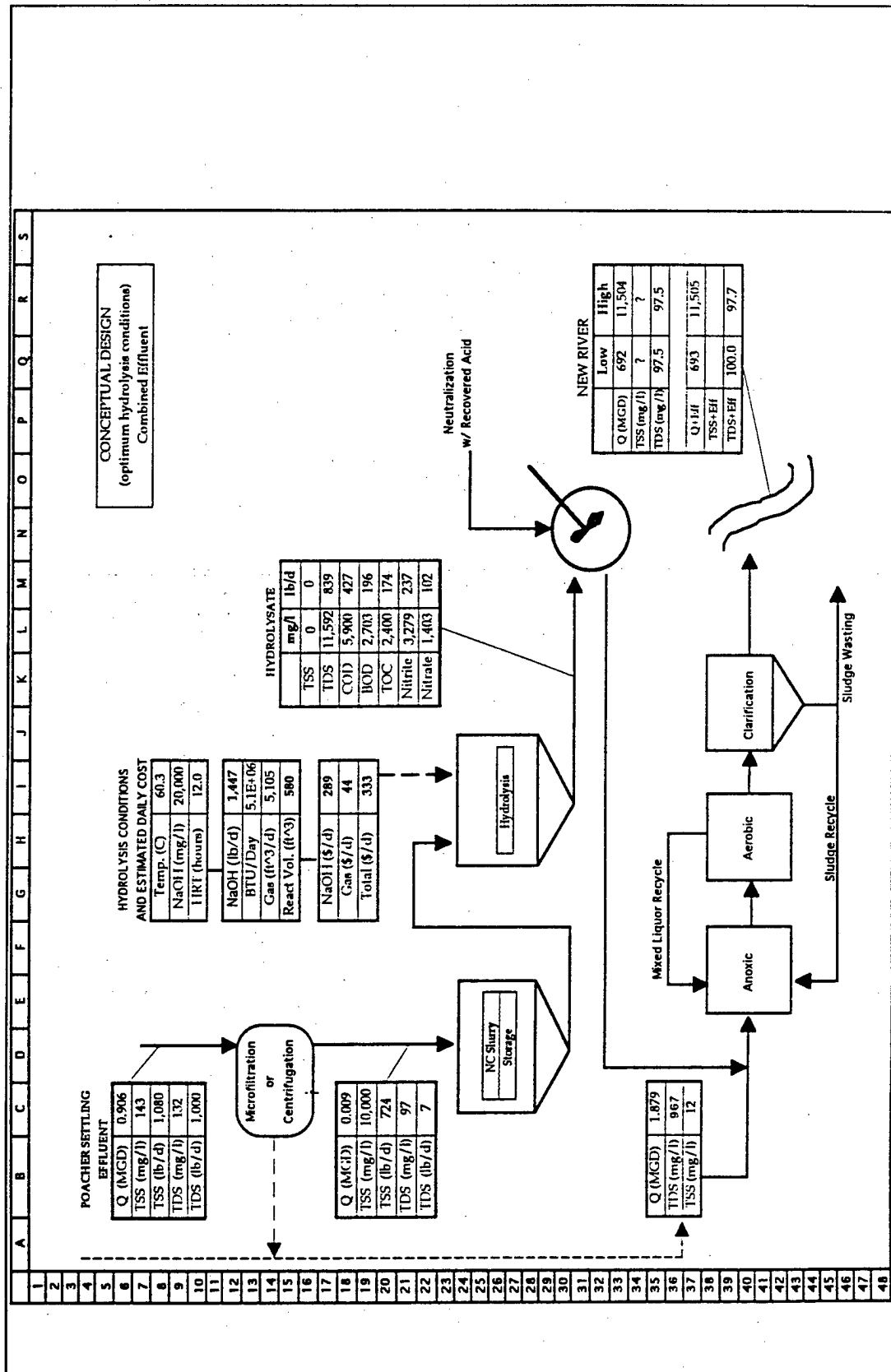

Figure 51. Conceptual design, optimum hydrolysis conditions.

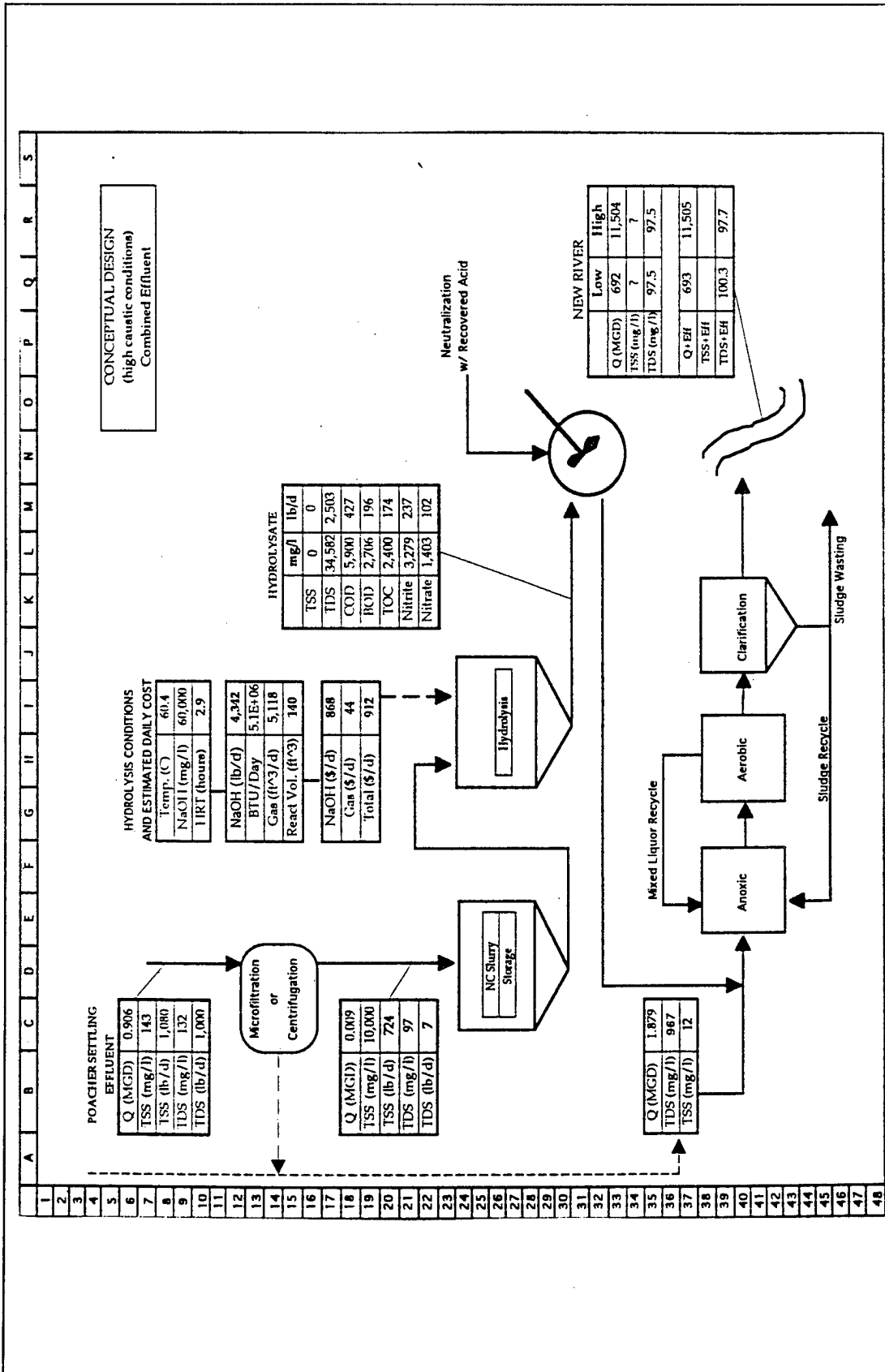

Figure 52. Conceptual design, high caustic hydrolysis conditions.

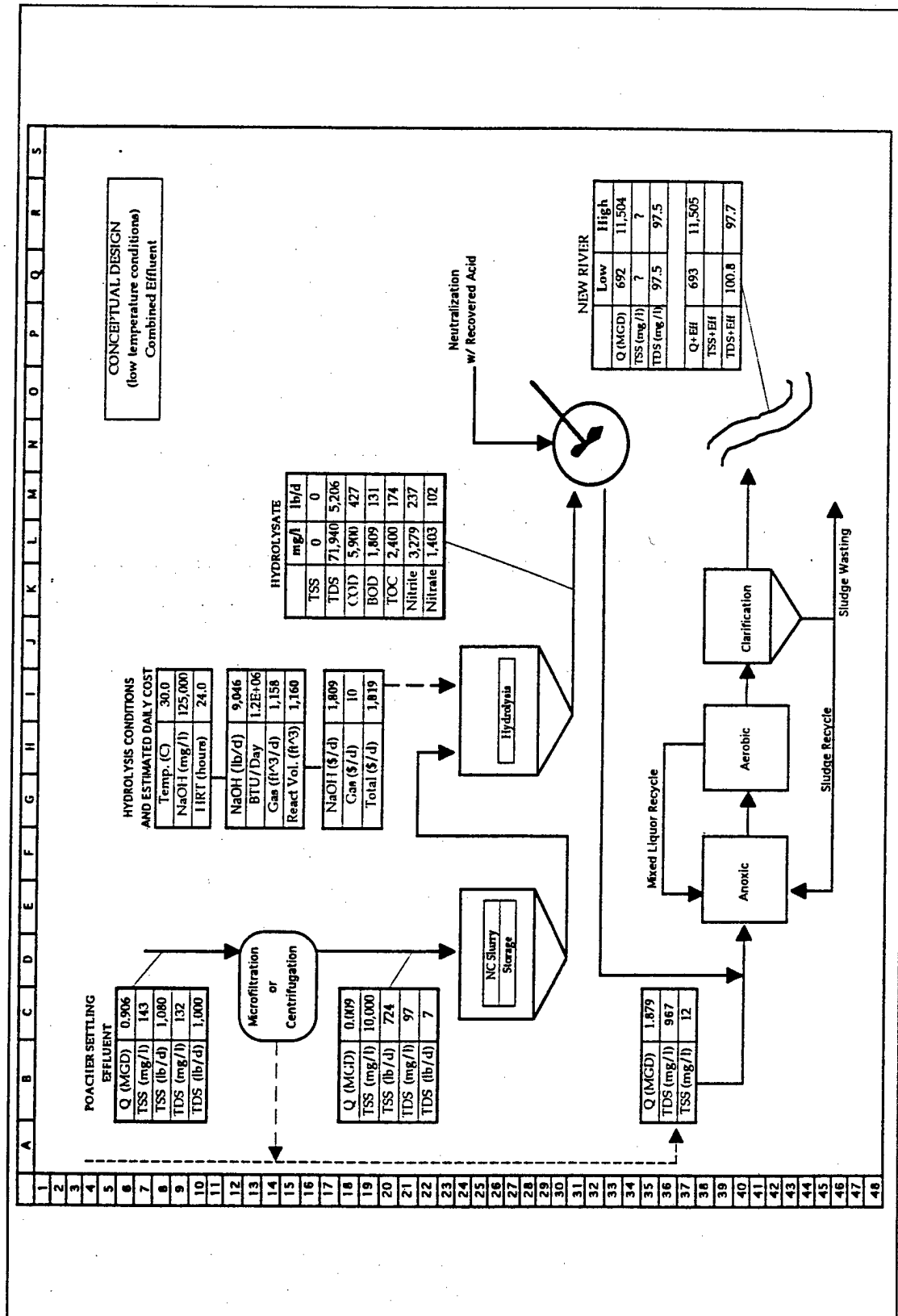

Figure 53. Conceptual design, low temperature hydrolysis conditions.

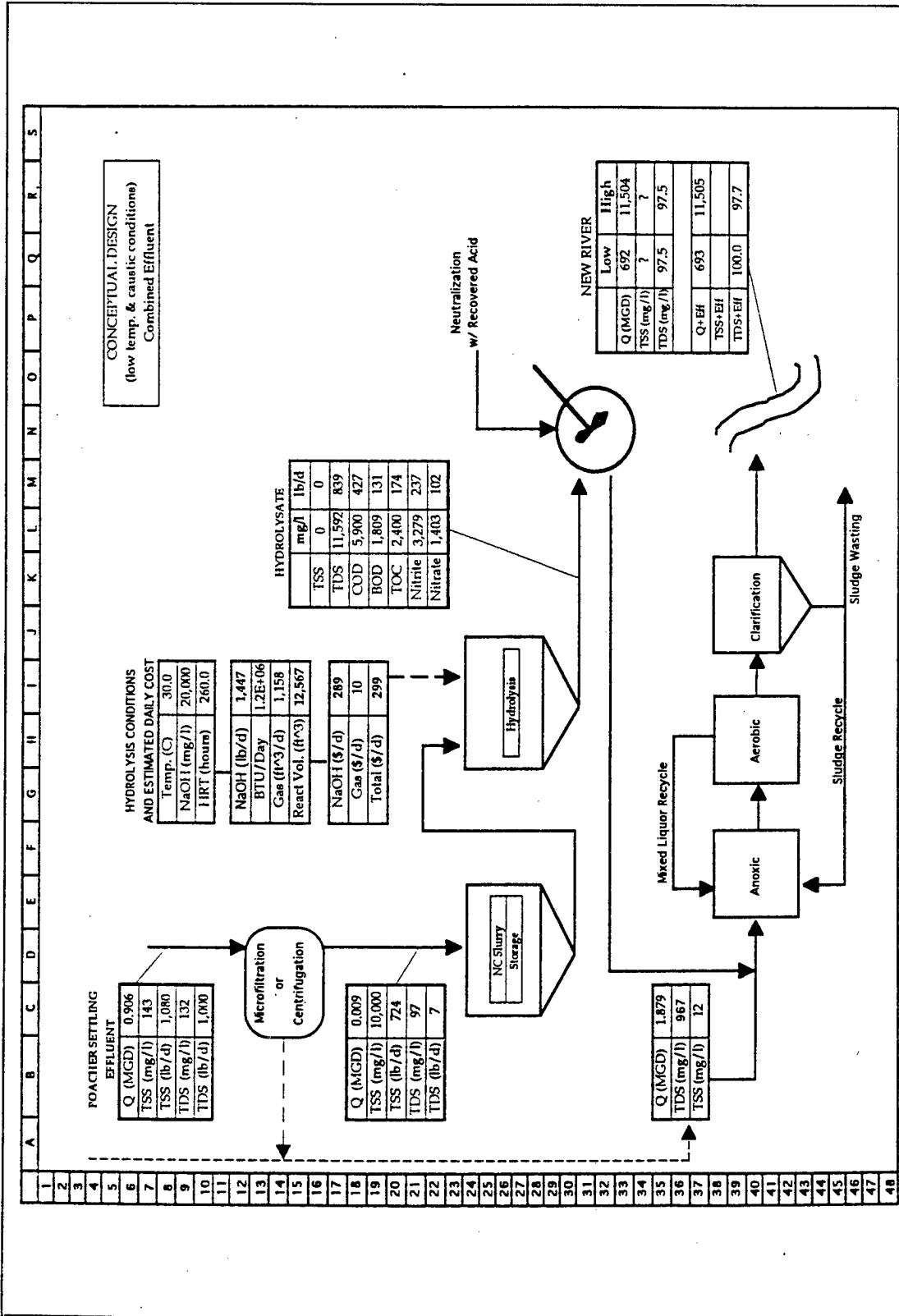

Figure 54. Conceptual design, low temperature and caustic hydrolysis conditions.

6 Conclusions and Recommendations

1. It has been determined that low caustic concentrations (~20,000 mg/L) and slightly elevated temperatures (50 to 70 °C) provided the optimum conditions for the alkaline hydrolysis process within the parameter ranges studied. Since caustic concentrations below 20,000 mg/L were not evaluated, it is recommended that a limited number of tests be run, on a pilot scale, using caustic concentrations in the range of 10,000 to 20,000 mg/L.
2. A pilot scale alkaline hydrolysis system currently exists. It is recommended that this pilot scale plant be used to investigate the low caustic dose/intermediate temperature alkaline hydrolysis on a larger scale. This pilot scale investigation should also evaluate the relative merits of treating the NC slurry in a continuous flow stirred tank reactor as opposed to the batch reactor configuration. Biological treatment of the hydrolysate should also be incorporated.
3. A more detailed chemical analysis needs to be completed on the hydrolysate prepared under the proposed "optimum" conditions. Namely, HPLC and/or LC/MS analysis would be beneficial.

The process of alkaline hydrolysis for the elimination of NC manufacturing residuals has been shown, experimentally, to be both effective and predictable. The treatment can result in 100 percent solubilization of the waste NC, converting an initially hazardous, nonbiodegradable particulate into degraded substrate amenable to subsequent biological treatment. The reaction is carried out at atmospheric pressure using relatively low caustic concentrations, and relatively low temperatures (30 to 70 °C). It is, therefore, safer, less expensive and less corrosive than previously proposed processes using this technology.

The significant findings and conclusions resulting from this research are:

1. The munitions-grade NC waste suspension from the RAAP contained 24.0 ± 1.0 percent carbon and 13.15 percent nitrogen by weight, resulting in an average molecular weight of 280.65.
2. The alkaline hydrolysis treatment process resulted in 100 percent solubilization of a 10,000 mg/L NC waste suspension. The optimum

hydrolysis conditions for this solubilization, as determined by nonlinear optimization of the theoretical solubilization equation, were a hydrolysis temperature of 60.3 °C using a caustic concentration of 20,000 mg/L and a 12-hour contact time. This finding is of particular importance in that the TSS concentration is the water quality criteria limiting the NC discharge from the RAAP. Under the current discharge permit, this limit is 40 mg/L. At present, the plant effluent contains 25 mg/L TSS, thereby meeting current permit requirements. However, it is expected that the TSS permit limit will be lowered in the future.

3. The solubilization of the nitrocellulose, on alkaline hydrolysis, was a predictable reaction following pseudo-first-order kinetics. In addition, this reaction depended on the caustic dose employed in the reaction, the contact time and the hydrolysis temperature.
4. The alkaline hydrolysis reaction resulted in the complete denitration of the NC polymer. This denitration reaction closely paralleled the solubilization reaction resulting in the recovery of ~100 percent of the constituent nitrogen as nitrite and nitrate.
5. The denitration of the NC was also predictable, following pseudo-first-order kinetics. As with the solubilization reaction, this reaction depended on the hydrolysis time, temperature, and caustic dose.
6. A mass balance on nitrogen following the hydrolysis of a 10,000 mg/L munitions-grade NC sample showed that approximately 100 percent of the soluble nitrogen was present in the hydrolysate as nitrite and nitrate. While much effort went into determining both ammonia and cyanide concentrations, these two nitrogen species accounted for less than 0.2 percent of the total nitrogen present following both "soft" and "hard" hydrolysis (Table 25).
7. A mass balance on soluble carbon following the hydrolysis of a 10,000 mg/L munitions-grade NC sample showed carbon losses as carbon dioxide to be insignificant under the most severe hydrolysis conditions tested. Under these same conditions, carbon in the form of carbohydrates accounted for 1,032 mg/L as C. The remaining 1,160 mg/L as C were attributed to organic species with oxidation states greater than zero but less than plus four (Table 26).
8. Amenability to biodegradation was observed for all hydrolysate samples, but in all cases, there was still a nonbiodegradable organic fraction.

9. The average oxidation state of those organics removed via biodegradation decreased as the severity of the treatment conditions increased.
10. The average oxidation state of those organics remaining in the hydrolysate following biodegradation increased as the severity of the treatment conditions increased. The residual organics were more oxidized.
11. The toxicity of the hydrolysate samples to Microtox test organisms decreased as the severity of the hydrolysis conditions increased. EC50 values under the anticipated operating conditions ranged from 20 to 33 percent hydrolysate before undergoing biological treatment. This toxicity would, therefore, be eliminated following dilution in excess of three to five fold.
12. TDS concentrations as high as 6,700 mg/L were found to have no inhibitory effect on biodegradation as evidenced by the performance of the pilot scale bio-reactors. The TDS concentrations predicted in Figure 5.2 (1,050 mg/L) on full scale implementation should, therefore, not be inhibitory.
13. A pilot scale CFSTR fed the digested nitrocellulose as its sole substrate, achieved 78 percent nitrite removal at steady state operation. Because the reactor was operated under continuous aeration, denitrification was inhibited. A 2 percent nitrate removal was observed, however, owing to denitrification in the clarifier. The reactors also achieved 23 percent TOC removal, and 43 percent COD removal.
14. The results of the design model show that low caustic concentrations (~20,000 mg/L) in combination with intermediate reaction temperatures (50-70 °C) will provide the most attractive treatment conditions, within the range of conditions studied. These treatment conditions not only result in the most efficient treatment in terms of reaction optimization, but also the most economical treatment.
15. TDS concentrations predicted in the conceptual design should not have an effect on the full scale biological treatment system based on the result of the pilot scale tests. In addition, because the TDS concentration in the New River is already quite high (e.g., 98 mg/L) the TDS of the effluent will only raise the river TDS by 3 mg/L under low monthly average river flow conditions for 1993.

Bibliography

- Abel, F., *Comp. Rend.* vol 69 (1869), pp 105.
- Abel, F., and E. Brown (1868), as quoted by T. Urbanski, *Chemistry and Technology of Explosives*, vol 2 (Pergamon Press, Oxford, England, 1964), p 215.
- Akhazarova, S., and V. Kafarov, *Experiment Optimization in Chemistry and Chemical Engineering* (Mir Publishers, Moscow, 1982).
- Arrhenius, S., as quoted by W. Stumm and J. Morgan, *Aquatic Chemistry: An Introduction Emphasizing Chemical Equilibria in Natural Waters*, 2d ed. (John Wiley & Sons, Inc, 1981) pp 95-96.
- Azanchev, N.M., Ye.N. Sergeyev, V.F. Sopin, V.I. Kovalenko, Ye.M. Belova, and G.N. Marchenko, "A ¹³C NMR Study of Cellulose Nitrates," *Polymer Science U.S.S.R.*, vol 29, No. 5 (1987), pp 1111-1117.
- Baker and Easty (1950), as quoted by F.D. Miles, *Cellulose Nitrate, The Physical Chemistry of Nitrocellulose, its Formation and Use* (Interscience Publishers, Inc. New York, 1964).
- Balasco, A.A., Program Manager, "Engineering/Cost Evaluation of Options for Removal/Disposal of NC Fines," Final Report to United States Army Toxic and Hazardous Materials Agency (Arthur D. Little, Inc., 1987).
- Belkacemi, K., N. Abatzoglou, R.P. Overend, and E. Chornet, "Phenomenological Kinetics of Complex Systems: Mechanistic Considerations in the Solubilization of Hemicelluloses following Aqueous/Steam Treatments," *Ind. Eng. Chem. Res.*, vol 30 (1991), pp 2416-2425.
- Blackwell, J., and R.H. Marchessault, in "Cellulose and Cellulose Derivatives," N.M. Bikales and L. Segal, eds. (Wiley-Interscience, New York, 1971), pp 1-37.
- Blazej, A., and M. Kosik, In "Cellulose and its Derivatives: Chemistry, Biochemistry and Applications," J.F. Kennedy, G.O. Phillips, D.J. Wedlosck and P.A. Williams, eds. (Ellis Horwood, Chichester, 1985), pp 97-117.
- Braconnot, H. (1833), as quoted by T. Urbanski, "Chemistry and Technology of Explosives," vol 2 (Pergamon Press, Oxford, England, 1964), p 213.
- Brown, R.D., Jr., and L. Jurasek, eds., "Hydrolysis of Cellulose: Mechanisms of Enzymatic and Acid Catalysis," *Advances in Chemistry Series* (American Chemical Society, Washington, DC, 1979).
- Chichirov, A.A., A.V. Kuznetsov, Yu.M. Kargin, V.V. Klochkov, G.N. Marchenko, and G.G. Garifzyanov, "Equilibrium in the Cellulose Nitrates-Nitric Acid System," *Polymer Science U.S.S.R.*, vol 32, No. 3 (1990), pp 441-446.
- Dey, P.M., and J.B. Harborne, *Methods in Plant Biochemistry* (Academic Press Limited, 1990).

- Dorée, C., *The Methods of Cellulose Chemistry*, 2d ed. (Chapman & Hall LTD., London, 1950).
- Dubois, M., K.A. Gilles, J.K. Hamilton, P.A. Rebers, and F. Smith, "Colorimetric Method for Determination of Sugars and Related Substances," *Analytical Chemistry*, vol 28, No. 3, (1956), pp 350-356.
- Duran, M., B.J. Kim, and R. Speece, in *Nitrocellulose Workshop Proceedings: Fines Separation and Treatment*, J.E. Alleman and B.J Kim, eds. (Purdue University, 1993), pp 92-108.
- Eastman, J.A., and J.F. Ferguson, "Solubilization of Particulate Organic Carbon During the Acid Phase of Anaerobic Digestion," *Jour. Water Poll. Control Fed.*, vol 53, No. 3 (1981), pp 352-366.
- Evans, et al. (1936), as quoted by F.D. Miles, in *Cellulose Nitrate, The Physical Chemistry of Nitrocellulose, its Formation and Use* (Interscience Publishers, Inc. New York, 1955).
- Fan, L.T., M.M. Gharpuray, and Y.H. Lee, *Cellulose Hydrolysis* (Springer-Verlag, Berlin Heidelberg, 1987).
- Fordham, S., *High Explosives and Propellants* (Pergamon Press, 1980).
- Fox, D.J., P.P. Gray, N.W. Dunn, and W.L. Marsden, "Factors Affecting the Enzymic Susceptibility of Alkali and Acid Pretreated Sugar-cane Bagasse," *J. Chem. Tech. Biotechnol.*, vol 40 (1987), pp 117-132.
- Franz, G., and W. Blaschek, in *Methods in Plant Biochemistry*, vol 2 (Academic Press, Ltd, 1990), pp 291-322.
- French, A.D., in *Cellulose Chemistry and its Applications*, T.P. Nevell and S.H. Zeronian, eds., (Ellis Horwood, Chichester, 1985), pp 84-111.
- Gallo, B., A. Allen, R.L. Bagalawis, C. Woodbury, A. Yang, P. Austin, and D. Kaplan, In *Nitrocellulose Workshop Proceedings: Fines Separation and Treatment*, J.E. Alleman and B.J Kim, eds. (Purdue University, 1993), pp 78-99.
- Gascoigne, J.A., and M.M. Gascoigne, *Biological Degradation of Cellulose*, J.W. Cook and M. Stacey, eds. (Butterworths, London, 1960).
- Gaudy, A.F., Jr., P.Y. Yang, and A.W. Obayashi, "Studies on the Total Oxidation of Activated Sludge With and Without Hydrolytic Pretreatment," *Jour. Water Poll. Control Fed.*, vol 43, No. 1 (1971), pp 40-54.
- Grethlein, H.E. (as quoted by A.E. Humphrey) in *Hydrolysis of Cellulose: Mechanisms of Enzymatic and Acid Catalysis*, R.D. Brown, Jr., and Lubo Jurasek, eds. (American Chemical Society, 1975).
- Hirayama, L. K., and L.L. Smith, *Pilot-Scale Demonstration of Laboratory Developed Operating Conditions for Alkaline Hydrolysis of Nitrocellulose Fines* (Hercules Inc., Radford Army Ammunition Plant, Radford, VA, 1988).
- Hiroka, M., N. Takeda, S. Sakai, and A. Yasuda, "Highly Efficient Anaerobic Digestion With Thermal Pretreatment," *Water Sci. Tech.*, vol 17 (1984), pp 529-539.
- Hon, D., and N. Shiraishi, *Wood and Cellulosic Chemistry* (Marcel Dekker, Inc. New York, 1990).

- Hoshino, M., M. Takai, K. Fukuda, K. Imura, and J. Hayashi, "13C-NMR Study of Cellulose Derivatives in the Solid State," *Journal of Polymer Science: Part A: Polymer Chemistry*, vol 27 (1989), pp 2083-2092.
- Hsieh, H.N., and F-J. Tai, in *Nitrocellulose Workshop Proceedings: Fines Separation and Treatment*, J.E. Alleman and B.J Kim, eds. (Purdue University, 1993), pp 110-121.
- Humphrey, A.E., in *Hydrolysis of Cellulose: Mechanisms of Enzymatic and Acid Catalysis*, R.D. Brown, Jr., and Lubo Jurasek, eds. (American Chemical Society, 1979).
- Jackson and Hudson (1936), as quoted by F.D. Miles, *Cellulose Nitrate, The Physical Chemistry of Nitrocellulose, its Formation and Use* (Interscience Publishers, Inc. New York, 1955).
- Jeffries, T.W., in *Wood and Cellulosics: Industrial Utilization, Biotechnology, Structure and Properties*, J.F. Kennedy, G.O. Phillips, and P.A. Williams, eds. (Ellis Horwood, Ltd., Chichester, 1987), pp 213-230.
- Jorgensen, L., *Studies on The Partial Hydrolysis of Cellulose* (Trykt Hos Emil Moestue A/S, Oslo, 1950).
- Kenyon, W.O., and H. LeB. Gray, "The Alkaline Decomposition of Cellulose Nitrate, I. Quantitative Studies," *Jour. Amer. Chem. Soc.*, vol 58 (1936), pp 1422-1427.
- Kim, B.J., and J.K. Park, in *Nitrocellulose Workshop Proceedings: Fines Separation and Treatment*, J.E. Alleman and B.J Kim, eds. (Purdue University, 1993), pp 1-10.
- Kim, B.J., et al., *Evaluation of Crossflow Microfiltration for Removing Nitrocellulose Fines From Wastewater*, Technical Report (TR) EP-95/04/ADA298625 (U.S. Army Construction Engineering Research Laboratories [USACERL], April 1995).
- Kim, B.J., M. Clark, and Y. Lee, *Comparative Evaluation of Ultrafiltration/Microfiltration Membranes for the Removal of Nitrocellulose Fines From Process Water*, TR 97/16 (USACERL, September 1997).
- Kim, B.J., J. Park, and L. Clapp, *Characterization of Nitrocellulose Fines in Manufacturing Wastewater and Development of Pollution Prevention Strategy*, TR 97/138 (USACERL, September 1997).
- Krassig, H., in *Cellulose and its Derivatives: Chemistry, Biochemistry and Applications*, J.F. Kennedy, G.O. Phillips, D.J. Wedlosck, and P.A. Williams, eds. (Ellis Horwood, Chichester, 1985), pp 3-25.
- Logan, B.E., Q. and Jiang, "Molecular Size Distributions of Dissolved Organic Matter," *Jour. of Envir. Engr.*, vol 116, No. 6 (1990), pp 1046-1060.
- Lowe, W., in *Nitrocellulose Workshop Proceedings: Fines Separation and Treatment*, J.E. Alleman and B.J Kim, eds. (Purdue University, 1993), pp 136-149.
- Lure, B.A., Z.T. Valishina, and B.S. Svetlov, "Kinetics and Mechanism of the Chemical Transformation of Nitrocellulose Under the Action of Aqueous Sulfuric Acid Solutions," *Polymer Science USSR*, vol 33, No. 1 (1991), pp 99-106.
- Mark H., and L. Misch, *Helv. Chim. Acta*, vol 20 (1937), p 232.

- Mascini, M., M. Pizzichini, D. Moscone, and R. Pilloton, "On-Line Determination of Glucose Produced by Hydrolysis of Cellobiose Realized With a Cellular Bioreactor," *Biotechnology and Bioengineering*, vol 34 (1989), pp 262-264.
- Mason, R.L., R.F. Gunst, and J.L. Hess, *Statistical Design and Analysis of Experiments* (John Wiley and Sons, New York, 1989).
- Mendeleyev, D.I. (1895), as quoted by T. Urbanski, *Chemistry and Technology of Explosives*, vol 2 (Pergamon Press, Oxford, England, 1964), p 215.
- Meyer, K.H., and H. Mark, *Z. Physik. Chem.* (1929), pp B2, 115.
- Miles, F.D., *Cellulose Nitrate, The Physical Chemistry of Nitrocellulose, Its Formation and Use* (Interscience Publishers, Inc. New York, 1955).
- Mudrack, K., "Nitro-Cellulose Industrial Waste," *Engineering Bulletin*, vol L, No. 2 (Purdue University, 1966), pp 656-664.
- Mukherjee, S.R., and A.D. Levine, "Chemical Solubilization of Particulate Organics as a Pretreatment Approach," *Water, Science and Technology*, vol 26, No. 9-11 (1992), pp 2289-2292.
- Nageli, C. (1858), as quoted by T. Urbanski, *Chemistry and Technology of Explosives*, vol 2 (Pergamon Press, Oxford, England, 1964), p 221.
- Nassar, R., S.T. Chou, and L.T. Fan, "Stochastic Analysis of Stepwise Cellulose Degradation," *Chemical Engineering Science*, vol 46, No. 7 (1991), pp 1651-1657.
- Nigmatullin, R.R., M.T. Bryk, and I.D. Atamanenko, "Alkaline Saponification and Its Effect on the Properties of Cellulose Acetate Ultrafiltration Membranes," *Polymer Science USSR*, vol 32, No. 8 (1990), pp 1583-1588.
- Pavlostathis, S.G., and J.M. Gossett, "A Kinetic Model for Anaerobic Digestion of Biological Sludge," *Biotechnol. and Bioeng.*, vol 28 (1986), pp 1519-1530.
- Pelouze, J.H. (1838), quoted by T. Urbanski, in *Chemistry and Technology of Explosives*, vol 2 (Pergamon Press, Oxford, England, 1964), p 214.
- Peng, C.G., J.K. Park, and B.J. Kim, in *Nitrocellulose Workshop Proceedings: Fines Separation and Treatment*, J.E. Alleman, and B.J Kim, eds. (Purdue University, 1993), pp 22-29.
- Pesari, H., and D. Grasso, "Biodegradation of an Inhibitory Nongrowth Substrate (Nitroglycerin) in Batch Reactors), *Biotechnology and Bioengineering*, vol 41 (1993), pp 79-87.
- Peters, L.E., L.P. Walker, D.B. Wilson, and D.C. Irwin, "The Impact of Initial Particle Size on the Fragmentation of Cellulose by the Cellulases of *Thermomonospora fusca*," *Bioresource Technology*, vol 35 (1991), pp 313-319.
- Petitpas, T., and M. Mathieu (1946), as quoted by T. Urbanski, in *Chemistry and Technology of Explosives*, vol 2 (Pergamon Press, Oxford, England, 1964), p 243.
- Quinchon, J., and J. Tranchant, *Nitrocelluloses, the Materials and Their Applications in Propellants, Explosives and Other Industries* (Ellis Horwood Limited, England, 1989).

- Rajan, R.V., J. Lin, and B.T. Ray, "Improved Anaerobic Digestion With Low Level Chemical Pretreatment," *Proc. of the 43rd Purdue Ind. Waste Conf.* (1989), pp 327-337.
- Reese, E.T., et al. (1957), as quoted by L.T. Fan, *Cellulose Hydrolysis* (Springer-Verlag, Berlin Heidelberg, 1987).
- Roberts, W., and Hartley (1992), *Drinking Water Health Advisory: Minitions* (CRC Press, Boca Raton, FL, 1987).
- Rogovin, Z.A. (1936), as quoted by T. Urbanski, *Chemistry and Technology of Explosives*, vol 2 (Pergamon Press, Oxford, England, 1964), p 222.
- Saeman, J. (1945), as quoted by A.E. Humphrey, "Hydrolysis of Cellulose: Mechanisms of Enzymatic and Acid Catalysis, R.D. Brown, Jr., and Lubo Jurasek, eds. (*American Chemical Society*).
- Sarko, A. (1987), in *Wood and Cellulosics: Industrial Utilization, Biotechnology, Structure and Properties*," J.F. Kennedy, G.O. Phillips, and P.A. Williams, eds. (Ellis Horwood LTD, Chichester), pp 55-69.
- Schonbein, C.F. (1846), as quoted by T. Urbanski, *Chemistry and Technology of Explosives*, vol 2 (Pergamon Press, Oxford, England, 1964), p 214.
- Standard Methods for the Examination of Water and Wastewater*, 18th ed. (American Public Health Assoc., Washington, DC, 1991)
- Stuckey, D.C., and P.L. McCarty, "Thermochemical Pretreatment of Nitrogenous Materials To Increase Methane Yield," *Biotechnol. and Bioeng. Symp.*, vol 8 (1979), pp 219-233.
- Stumm, W., and J. Morgan, *Aquatic Chemistry: An Introduction Emphasizing Chemical Equilibria in Natural Waters*, 2d ed. (John Wiley & Sons, Inc., 1981).
- Tchobanoglous, G. and F.L. Burton, *Wastewater Engineering: Treatment, Disposal, and Reuse*, 3d ed. (Metcalf & Eddy, Inc., McGraw-Hill, Inc., 1991).
- Tewari, H.K., S.S. Marwaha, J.F. Kennedy, and L. Singh, "Evaluation of Acids and Cellulase Enzyme for the Effective Hydrolysis of Agricultural Lignocellulosic Residues," *J. Chem. Tech. Biotechnol.*, vol 41 (1988), pp 261-275.
- Thompson, D.N., H.C. Chen, and H.E. Grethlein, "Comparison of Pretreatment Methods on the Basis of Available Surface Area," *Bioresource Technology*, No. 39 (1992), pp 155-163.
- Tsapiuk, E.A., M.T. Bryk, V.M. Kochkodan, and E.E. Danilenko, "Separation of Aqueous Solutions of Nonionic Organic Solutes by Ultrafiltration," *Jour. of Mem. Sci.*, vol 48 (1990), pp 1-23.
- Ubukata, Y. "Kinetics of Polymeric Substrate Removal by Activated Sludge: Hydrolysis of Polymers Is the Rate-Determining Step," *Wat. Sci. Tech.*, vol 26, No. 9-11 (1992), pp 2457-2460.
- Urbanski, T., *Chemistry and Technology of Explosives*, vol 2, 3, and 4 (Pergamon Press, Oxford, England, 1964).
- Walker, L.P., and D.B. Wilson, "Enzymatic Hydrolysis of Cellulose: An Overview," *Bioresource Technology*, vol 36 (1991), pp 3-14.

- Walters, A.H. and J.J. Elphick, eds., "Biodeterioration of Materials: Microbiological and Allied Aspects," *Proceedings of the 1st International Biodeterioration Symposium Southampton, 9th - 14th September, 1968* (Elsevier Publishing Co. Ltd., 1968).
- Ward, K., Jr., and P.A. Seib, in *The Carbohydrates: Chemistry and Biochemistry*, 2d ed., vol IIA, W. Pigman and D. Horton, eds. (Academic Press, Inc., 1970), pp 413-445.
- Wendt, T.M., and A.M. Kaplan, "A Chemical-Biological Treatment Process for Cellulose Nitrate Disposal," *Journal of the Water Pollution Control Federation*, vol 48, No. 4 (1976), pp 660-668.
- Wendt, T.M., and A.M. Kaplan, *Process for Treating Wastewater Containing Cellulose Nitrate Particles*, U.S. Patent No. 3939068 (1976).
- Will, W. (1904), as quoted by F.D. Miles, *Cellulose Nitrate, The Physical Chemistry of Nitrocellulose, its Formation and Use* (Interscience Publishers, Inc. New York, 1955).
- Wood, T.M., and S.I. McCrae, in *Hydrolysis of Cellulose: Mechanisms of Enzymatic and Acid Catalysis*, R.D. Brown, Jr., and Lubo Jurasek, eds. (American Chemical Society, 1979), pp 189-209.
- Woodard, S.E., *A Hydrolysis/Thickening/Filtration Process for the Treatment of Waste Activated Sludge*, Ph.D. Thesis (School of Civil Engineering, Purdue University, West Lafayette, IN, 1992).
- Worden, E.C., *Nitrocellulose Industry* (D. Van Nostrand Company, New York, 1911).
- Yang, M., and M. Ramsey, in *Nitrocellulose Workshop Proceedings: Fines Separation and Treatment*, J.E. Alleman and B.J Kim, eds. (Purdue University, 1993), pp 42-49.

Abbreviations and Initialisms

AMU	Atomic mass unit
BOD ₅	5-day biochemical oxygen demand
BOD	Biochemical oxygen demand
CBOD	Carbonaceous biochemical oxygen demand
CCOD	Carbonaceous chemical oxygen demand
CFSTR	Continuous flow stirred tank reactor
COD	Chemical oxygen demand
EC	Effective concentration
EPA	Environmental Protection Agency
GC	Gas chromatography
GOD	Glucose oxygen demand
MLVSS	Mixed liquor volatile suspended solids
MS	Mass spectrometry
NC	Nitrocellulose
Q	Flow
RAAP	Radford Army Ammunition Plant
ROD	Residual oxygen demand
ThGLU	Theoretical glucose
ThOC	Theoretical organic carbon
ThOD	Theoretical oxygen demand

TOC	Total organic carbon
TSS	Total suspended solids
TU	Toxicity unit
USAAMCC	U.S. Army Armament Munitions Chemical Command
USATHAMA	U.S. Army Toxic and Hazardous Materials Agency
UV	Ultraviolet
VSS	Volatile suspended solids
WAS	Waste activated sludge

USACERL DISTRIBUTION

HQ IOC ATTN: AMSIO-EQC (2)	Defense Distribution Region East ATTN: ASCE-WI 17070-5001	ATTN: HONSHU 96343 ATTN: DPW-Okinawa 96376
US Army Environmental Center ATTN: SFIM-AEC-ET 21010-5401	US Army Materiel Command (AMC) Alexandria, VA 22333-0001 ATTN: AMCEN-F ATTN: AMXEN-C 61299-7190 Installations: (20)	416th Engineer Command 60623 ATTN: Gibson USAR Ctr
Chief of Engineers ATTN: CEHEC-IM-LH (2) ATTN: CEHEC-IM-LP (2) ATTN: CECG ATTN: CECC-P ATTN: CECC-R ATTN: CECW ATTN: CECW-O ATTN: CECW-P ATTN: CECW-PR ATTN: CEMP ATTN: CEMP-E ATTN: CEMP-C ATTN: CEMP-M ATTN: CEMP-R ATTN: CERD-C ATTN: CERD-ZA ATTN: CERD-L ATTN: CERD-M (2)	FORSCOM Forts Gillem & McPherson 30330 ATTN: FCEN Installations: (20)	Tyndall AFB 32403 ATTN: Engrg & Srvc Lab
	TRADOC Fort Monroe 23651 ATTN: ATBO-G Installations: (19)	American Public Works Assoc. 64104-1806
	Fort Belvoir 22060 ATTN: CEDEC-IM-T ATTN: Water Resources Support Ctr	US Army CHPPM ATTN: MCHB-DE 21010
	US Army Materials Tech Lab ATTN: SLCMT-DPW 02172	US Army Envr Hygiene Agency ATTN: HSHB-ME 21010
CEISC 22310-3862 ATTN: CEISC-E ATTN: CEISC-FT ATTN: CEISC-ZC	USA Natick RD&E Center 01760 ATTN: STRNC-DT ATTN: AMSSC-S-IMI	US Gov't Printing Office 20401 ATTN: Rec Sec/Deposit Sec (2)
US Army Engr District ATTN: Library (40)	US Army Materials Tech Lab ATTN: SLCMT-DPW 02172	Nat'l Institute of Standards & Tech ATTN: Library 20899
US Army Engr Division ATTN: Library (8)	CEWES 39180 ATTN: Library	Defense Tech Info Center 22060-6218 ATTN: DTIC-O (2)
US Army Europe ATTN: AEAEN-EH 09014 ATTN: AEAEN-ODCS 09014 29th Area Support Group ATTN: AEUSG-K-E 09054 222d BSB Unit #23746 ATTN: AETV-BHR-E 09034 235th BSB Unit #28614 ATTN: AETV-WG-AM 09177 293d BSB Unit #29901 ATTN: AEUSG-MA-E 09086 409th Support Battalion (Base) ATTN: AETTG-DPW 09114 412th Base Support Battalion 09630 ATTN: Unit 31401 221st Base Support Battalion ATTN: Unit 29623 09096 CMTC Hohenfels 09173 ATTN: AETTH-SB-DPW Mainz Germany 09185 ATTN: AETV-MNZ-E 21st Support Command ATTN: DPW (8) SETAF ATTN: AESE-EN-D 09613 ATTN: AESE-EN 09630	US Army Materials Tech Lab ATTN: SLCMT-DPW 02172	
Supreme Allied Command ATTN: ACSGEB 09703 ATTN: SHIHB/ENGR 09705	CECRL 03755 ATTN: Library	
INSCOM ATTN: IALOG-I 22060 ATTN: IAV-DPW 22186	USA AMCOM ATTN: Facilities Engr 21719 ATTN: AMSMC-EH 61299 ATTN: Facilities Engr (3) 85613	
USA TACOM 48397-5000 ATTN: AMSTA-XE	USA Engr Activity, Capital Area ATTN: Library 22211	
	US Army ARDEC 07806-5000 ATTN: AMSTA-AR-IMC	
	Engr Societies Library ATTN: Acquisitions 10017	
	Defense Nuclear Agency ATTN: NADS 20305	
	Defense Logistics Agency ATTN: MMBIR 22060-6221	
	Walter Reed Army medical Cntr 20307	
	National Guard Bureau 20310 ATTN: NGB-ARI	
	US Military Academy 10996 ATTN: MAEN-A ATTN: Facilities Engineer ATTN: Geography & Envr Engrg	
	Naval Facilities Engr Command ATTN: Facilities Engr Command (8) ATTN: Naval Facil. Engr. Service Ctr 93043-4328	
	8th US Army Korea ATTN: DPW (11)	
	USA Japan (USARJ) ATTN: APAJ-EN-ES 96343	